



Maintenance and Service Guide

HP Pavilion Widescreen

Notebook zt3000

HP Compaq Business Notebook nx7000

Compaq Presario Widescreen

Notebook PC X1000

Document Part Number: 325388-002

October 2003

This guide is a troubleshooting reference used for maintaining and servicing the notebook. It provides comprehensive information on identifying notebook features, components, and spare parts, troubleshooting notebook problems, and performing notebook disassembly procedures.

© 2003 Hewlett-Packard Development Company, L.P.

Microsoft® and Windows® are U.S. registered trademarks of Microsoft Corporation. Intel®, Pentium®, and SpeedStep® are trademarks or registered trademarks of Intel Corporation or its subsidiaries in the United States and other countries. SD Logo is a trademark of its proprietor. Bluetooth® is a trademark owned by its proprietor and used by Hewlett-Packard Company under license.

The information contained herein is subject to change without notice. The only warranties for HP products and services are set forth in the express warranty statements accompanying such products and services. Nothing herein should be construed as constituting an additional warranty. HP shall not be liable for technical or editorial errors or omissions contained herein.

Maintenance and Service Guide

HP Pavilion Widescreen Notebook zt3000

HP Compaq Business Notebook nx7000

Compaq Presario Widescreen Notebook PC X1000

Second Edition October 2003

First Edition July 2003

Document Part Number: 325388-002

Contents

1 Product Description

1.1 Models	1–2
1.2 Features	1–22
1.3 Clearing a Password	1–24
1.4 Power Management	1–25
1.5 External Components	1–26
1.6 Design Overview	1–36

2 Troubleshooting

2.1 Computer Setup and Diagnostics Utilities	2–1
Using Computer Setup	2–2
Selecting from the File Menu	2–3
Selecting from the Security Menu	2–4
Selecting from the Advanced Menu	2–5
2.2 Troubleshooting Flowcharts	2–7

3 Illustrated Parts Catalog

3.1 Serial Number Location	3–1
3.2 Notebook Major Components	3–2
3.3 Miscellaneous Plastics Kit Components	3–10
3.4 Miscellaneous Cable Kit Components	3–12
3.5 Miscellaneous Doors/Covers Kit Components	3–13
3.6 Mass Storage Devices	3–14
3.7 Miscellaneous	3–15

4 Removal and Replacement Preliminaries

4.1 Tools Required	4-1
4.2 Service Considerations	4-2
Plastic Parts	4-2
Cables and Connectors	4-2
4.3 Preventing Damage to Removable Drives	4-3
4.4 Preventing Electrostatic Damage	4-4
4.5 Packaging and Transporting Precautions	4-4
4.6 Workstation Precautions	4-5
4.7 Grounding Equipment and Methods	4-6

5 Removal and Replacement Procedures

5.1 Serial Number	5-2
5.2 Disassembly Sequence Chart	5-3
5.3 Preparing the Notebook for Disassembly	5-4
5.4 Notebook Feet	5-8
5.5 Memory Expansion Board	5-9
5.6 Mini PCI Communications Board	5-11
5.7 RTC Battery	5-13
5.8 Optical Drive	5-14
5.9 Keyboard	5-15
5.10 Switch Cover	5-18
5.11 Speaker Cover	5-19
5.12 Fan	5-21
5.13 Heat Sink	5-22
5.14 Processor	5-24
5.15 Display Assembly	5-26
5.16 Top Cover	5-30
5.17 Bluetooth Board	5-36
5.18 SD Card Slot Board and Cable	5-38
5.19 VGA Board and Shield	5-40
5.20 Modem and Cable	5-42
5.21 System Board	5-44

6 Specifications

A Connector Pin Assignments

B Power Cord Set Requirements

3-Conductor Power Cord Set	B-1
General Requirements	B-1
Country-Specific Requirements	B-2

C Screw Listing

Index

Product Description

The HP Pavilion Widescreen Notebook zt3000, HP Compaq Business Notebook nx7000, and Compaq Presario Widescreen Notebook PC X1000 offer advanced modularity, a Mobile Intel® Pentium® 4 Processor-M processor with 64-bit architecture, industry-leading ATI MOBILITY RADEON Accelerated Graphics Port (AGP) implementation, and extensive multimedia support.



*HP Pavilion Widescreen Notebook zt3000,
HP Compaq Business Notebook nx7000, and
Compaq Presario Widescreen Notebook PC X1000*

1.1 Models

Notebook models are shown in Tables 1-1 through 1-4.

**Table 1-1
HP Pavilion zt3000, HP Compaq nx7000,
and Compaq Presario X1000
Model Naming Conventions**

Key										
C	P	170	Y5	80	Y	Ci	10	P	XXXXXXXX-XXX	
1	2	3	4	5	6	7	8	9	10	
Key	Description	Options								
1	Brand/Series designator	V = HP Pavilion zt3000 C = HP Compaq nx7000					P = Compaq Presario X1000			
2	Processor type	P = Mobile Intel Pentium 4 Processor-M								
3	Processor speed	170 = 1.7 GHz 160 = 1.6 GHz 150 = 1.5 GHz					140 = 1.4 GHz 130 = 1.3 GHz			
4	Display type/size/resolution	Z = wide UXGA (1920 × 1200) Y = wide SXGA+ (1680 × 1050) W = wide XGA (1280 × 800)					5 = 15.4 in			
5	Hard drive size	80 = 80 GB 60 = 60 GB					40 = 40 GB			
6	Optical drive designator	C = CD-ROM D = DVD-ROM Y = DVD+RW					W = DVD/CD-RW combo drive			
7	Integrated communication/wireless device	C = combination LAN/modem b = 802.11b i = 802.11b + Bluetooth®								

Table 1-1
HP Pavilion zt3000, HP Compaq nx7000,
and Compaq Presario X1000
Model Naming Convention (*Continued*)

8	RAM	10 = 1024 MB 51 = 512 MB	25 = 256 MB
9	Operating system	H = Microsoft® Windows® XP Home P = Windows XP Pro	
10	SKU#		

Table 1-2
HP Pavilion zt3000 Models

All HP Compaq nx7000 models feature:

- TouchPad pointing device
- 8-cell, 4.4-wH lithium ion (Li-Ion) battery pack
- 1-year warranty on parts and labor

V	P	170	Y5	80	Y	Cb	51	H	
Asia Pacific			DR255A UUF						
V	P	160	Y5	80	Y	Cb	51	H	
Asia Pacific			DR260A UUF						
V	P	160	Y5	80	Y	Cb	25	H	
Taiwan			DR253A AB0 and DR258A AB0						
V	P	160	Y5	80	W	Ci	51	P	
Korea			DR248A AB1						
V	P	160	Y5	60	Y	Ci	51	H	
Hong Kong			DR249A AB5			Thailand		DR250A AKL	
V	P	160	Y5	60	Y	Ci	51	P	
Australia/New Zealand			DR244A ABG						

**Table 1-2
HP Pavilion zt3000 Models (Continued)**

V	P	160	Y5	60	W	Ci	51	P	
Korea			DR247A AB1						
V	P	160	Y5	40	W	Cb	25	H	
Asia Pacific			DR254A UUF			Taiwan		DR256A AB0	
V	P	160	W5	60	Y	Cb	51	H	
Greece			DP778E AB7			Switzerland		DP778E UUZ	
V	P	160	W5	60	W	Cb	51	H	
Hong Kong			DR257A AB5			Thailand		DR257A AKL	
V	P	150	Y5	40	W	Ci	25	P	
People's Republic of China			DR245A AB2						
V	P	150	W5	80	Y	Cb	51	H	
United States			DM779A ABA						
V	P	150	W5	60	Y	Cb	51	H	
United States			DM778A ABA						
V	P	150	W5	40	Y	Cb	51	H	
Switzerland			DP777E UUZ						
V	P	150	W5	40	Y	Cb	25	H	
Taiwan			DR252A AB0						
V	P	150	W5	40	Y	Cn	51	P	
Australia/New Zealand			DR243A ABG						
V	P	150	W5	40	W	Cb	51	H	
Denmark			DP779E ABY			The Netherlands		DP783E ABH	
Europe			DP779E ABB			Saudi Arabia		DP779E ABV	
Germany			DP782E ABD			Spain		DP779E ABE	
Italy			DP779E ABZ			United Kingdom		DP779E ABU	

Table 1-2
HP Pavilion zt3000 Models (Continued)

V	P	150	W5	40	W	Cb	25	H	
Asia Pacific			DR259A UUF						
V	P	140	W5	80	Y	Cb	51	P	
Latin America			DR205A ABM						
V	P	140	W5	60	W	Cb	51	H	
United States			DM781A ABA						
V	P	140	W5	40	Y	Cb	51	H	
France			DP786E ABF						
V	P	140	W5	40	W	Cb	51	H	
France			DP784E ABF						
Norway			DP785E ABN						
Germany			DM781E ABD						
United States			DM783A ABA						
V	P	140	W5	40	W	Cb	51	P	
Latin America			DR204A ABM						
V	P	140	W5	40	W	Cb	25	H	
Belgium			DP776E UUG			Norway		DP776E ABN	
Denmark			DP776E ABY			Portugal		DP776E AB9	
France			DP776E ABF			Saudi Arabia		DP776E ABV	
Europe			DP776E ABB			Spain		DP776E ABE	
Greece			DP776E AB7			Switzerland		DP776E UUZ	
Italy			DP776E ABZ			United Kingdom		DP776E ABU	
The Netherlands			DP776E ABH			United States		DP479U ABA	
V	P	140	W5	40	W	Ci	25	P	
Korea			DR246A AB1						
V	P	140	W5	40	W	Cn	25	P	
Australia/New Zealand			DR242A ABG						
V	P	140	W5	40	D	Cb	25	H	
Taiwan			DR251A AB0						

**Table 1-3
HP Compaq nx7000 Models**

All HP Compaq nx7000 models feature:

- TouchPad pointing device
- 8-cell, 4.4-wH Li-Ion battery pack
- 1-year warranty on parts and labor

C	P	160	Y5	80	W	Cb	51	P	
Korea			DM942A AB1						
C	P	160	Y5	60	Y	Ci	51	P	
France			DG706T ABF						
C	P	160	Y5	60	W	Cb	51	P	
Belgium			DG706A UUG			The Netherlands	DG706A ABH		
Czech Republic			DG706A AKB			Norway	DG706A ABN		
Denmark			DG706A ABY			Poland	DG706A AKD		
European International			DG706A ABB			Portugal	DG706A AB9		
France			DG706A ABF			Russia	DG706A ACB		
Germany			DG706A ABD			Saudi Arabia	DG706A ABV		
Greece			DG706A AB7			Slovenia	DG706A AKN		
Hungary			DG706A AKC			Spain	DG706A ABE		
Israel			DG706A ABT			Sweden/Finland	DG706A AK8		
Italy			DG706A ABZ			Switzerland	DG706A UUZ		
Japan			DM436A ABJ			Turkey	DG706A AB8		
						United Kingdom	DG706A ABU		
C	P	160	Y5	60	W	Ci	51	P	
Hong Kong			DR758P AB5						
C	P	160	W5	80	W	Cb	51	H	
Taiwan			DR749P AB0						
C	P	160	W5	80	W	Cb	51	P	
Asia Pacific			DR752P UUF			Thailand	DR752P AKL		
Taiwan			DR748P AB0						
C	P	160	W5	60	Y	Cb	51	P	
Thailand			DM434A AKL						

Table 1-3
HP Compaq nx7000 Models (Continued)

C	P	160	W5	60	W	Cb	51	P	
Asia Pacific			DM945A UUF and DL855A UUF			Japan		DL855A ABJ	
Brazil			DL855A AC4			Latin America		DL855A ABM	
French Canada			DL855A ABC			Thailand		DM945A AKL	
						United States		DL855A ABA	
C	P	160	W5	40	D	Cb	25	P	
Taiwan			DN896A AB0			People's Republic of China		DS303P AB2	
C	P	160	W5	40	D	CN	25	P	
Latin America			DP093A ABM			United States		DP093A ABA	
C	P	150	Y5	80	W	Cb	51	P	
Australia			DR764P ABG						
C	P	150	Y5	80	W	Ci	51	P	
Australia			DR760P ABG						
C	P	150	Y5	60	W	Cb	51	P	
Asia Pacific			DN894A UUF			Korea		DM941A AB1	
C	P	150	Y5	60	W	Cb	25	P	
Hong Kong			DR757P AB5						
C	P	150	Y5	60	W	Ci	25	P	
Hong Kong			DS304P AB5						
C	P	150	Y5	40	W	Cb	25	P	
Australia			DR762P ABG						
C	P	150	Y5	40	W	Ci	51	H	
Europe			DJ223S ABB						

**Table 1-3
HP Compaq nx7000 Models (Continued)**

C	P	150	Y5	40	W	Ci	51	P	
Belgium			DG705A UUG			Norway		DG705A ABN	
Czech Republic			DG705A AKB			Poland		DG705A AKD	
Denmark			DG705A ABY			Portugal		DG705A AB9	
Europe			DG705A ABB			Russia		DG705A ACB	
France			DG705A ABF and DG705T ABF			Saudi Arabia		DG705A ABV	
Germany			DG705A ABD and DG705T ABD			Slovenia		DG705A AKN	
Greece			DG705A AB7			Spain		DG705A ABE and DG705T ABE	
Hungary			DG705A AKC			Sweden/Finland		DG705A AK8	
Israel			DG705A ABT			Switzerland		DG705A UUZ	
Italy			DG705A ABZ			Turkey		DG705A AB8	
The Netherlands			DG705A ABH			United Kingdom		DG705A ABU and DG705T ABU	
C	P	150	Y5	40	W	Ci	25	P	
Italy			DJ218S ABZ						
C	P	150	Y5	40	C	Cb	51	P	
Korea			DM940A AB1						
C	P	150	W5	80	W	Cb	51	H	
Asia Pacific			DL848A UUF			Korea		DL848A AB1	
Australia/New Zealand			DL848A ABG			Taiwan		DL850A AB0	
Japan			DL848A ABJ			Thailand		DL848A AKL	
C	P	150	W5	80	W	Cb	51	P	
Asia Pacific			DL847A UUF			Korea		DL847A AB1	
Australia/New Zealand			DL847A ABG			Taiwan		DL849A AB0	
Japan			DL847A ABJ			Thailand		DL847A AKL	
C	P	150	W5	80	W	Cb	25	P	
Asia Pacific			DM943A UUF						
C	P	150	W5	60	W	Cb	25	H	
Taiwan			DR747P AB0						

Table 1-3
HP Compaq nx7000 Models (Continued)

C	P	150	W5	60	W	Cb	25	P	
People's Republic of China			DS302P AB2			Taiwan		DR746P AB0	
C	P	150	W5	40	W	Cb	51	H	
Switzerland			DJ169S UUZ						
C	P	150	W5	40	W	Cb	51	P	
Asia Pacific			DN728A UUF						
C	P	150	W5	40	W	Cb	25	P	
Asia Pacific			DM944A UUF			Australia		DS312P ABG	
C	P	150	W5	40	D	Cb	25	H	
Taiwan			DL842A AB0						
C	P	150	W5	40	D	Cb	25	P	
People's Republic of China			DQ885P AB2, DL838A AB2, and DS301P AB2						
C	P	140	Y5	60	W	Cb	25	P	
Australia			DR759P ABG						
C	P	140	Y5	40	W	Cb	51	P	
Korea			DM939A AB1						
C	P	140	Y5	40	W	Cb	25	P	
Australia			DR763P ABG			Hong Kong		DR756P AB5	
C	P	140	Y5	40	D	Cb	25	P	
Australia			DR761P ABG						
C	P	140	Y5	30	W	Cb	25	H	
Hong Kong			DR755P AB5						

**Table 1-3
HP Compaq nx7000 Models (Continued)**

C	P	140	W5	60	W	Cb	51	H	
Sweden			DJ200S AK8						
C	P	140	W5	60	W	Cb	25	H	
Asia Pacific			DL844A UUF			Korea		DL844A AB1	
Australia/New Zealand			DL844A ABG			Taiwan		DL846A AB0	
Hong Kong			DM437A AB5			Thailand		DL844A AKL	
Japan			DL844A ABJ						
C	P	140	W5	60	W	Cb	25	P	
Asia Pacific			DL843A UUF			Korea		DL843A AB1	
Australia/New Zealand			DL843A ABG			Taiwan		DL845A AB0	
Japan			DL843A ABJ			Thailand		DL843A AKL	
C	P	140	W5	60	W	Ci	51	P	
Asia Pacific			DL853A UUF			Hong Kong		DL853A ABF	
C	P	140	W5	60	W	Nb	51	H	
Europe			DQ822C ABB						
C	P	140	W5	40	W	Cb	25	H	
Japan			DM435A ABJ			Taiwan		DR750P AB0	
C	P	140	W5	40	W	Cb	25	P	
Thailand			DM433A AKL						
C	P	140	W5	40	W	Ci	51	H	
Germany			DJ202S ABD						

Table 1-3
HP Compaq nx7000 Models (Continued)

C	P	140	W5	40	W	Ci	25	P	
Belgium			DG704A UUG and DG704T UUG			Italy			DG704A ABZ
Czech Republic			DG704A AKB			The Netherlands			DG704A ABH
Denmark			DG704A ABY			Norway			DG704A ABN
Europe			DG704A ABB			Poland			DG704A AKD
France			DG704A ABF, DG704T ABF, and DJ231S ABF			Portugal			DG704A AB9
Germany			DG420A ABD			Russia			DG704A ACB
Greece			DG704A AB7			Saudi Arabia			DG704A ABV
Hungary			DG704A AKC			Slovenia			DG704A AKN
Israel			DG704A ABT			Spain			DG704A ABE
						Sweden/Finland			DG704A AK8
						Switzerland			DG704A UUZ
						Turkey			DG704A AB8
						United Kingdom			DG704A ABU
C	P	140	W5	40	W	Cn	25	P	
Brazil			DP094A AC4			United States			DP094A ABA
Latin America			DP094A ABM						
C	P	140	W5	40	D	Cb	51	P	
Brazil			DL854A AC4			Latin America			DL854A ABM
French Canada			DL854A ABC			United States			DL854A ABA and DP076C ABA
C	P	140	W5	40	D	Cb	25	H	
Hong Kong			DR754P AB5			Taiwan			DR745P AB0
C	P	140	W5	40	D	Cb	25	P	
Asia Pacific			DM438A UUF			Taiwan			DR744P AB0 and
Australia			DS311P ABG						DR751P AB0
Korea			DM938A AB1			Thailand			DM438A AKL
People's Republic of China			DL837A AB2 and DM438A AB2						

**Table 1-3
HP Compaq nx7000 Models (Continued)**

C	P	140	W5	40	C	Cb	25	P	
Asia Pacific			DR850P UUF			Korea		DM937A AB1	
C	P	140	W5	30	D	Cb	25	H	
Hong Kong			DR753P AB5						
C	P	130	Y5	80	W	Cb	51	P	
United States			DP113S ABA						
C	P	130	Y5	40	W	Cb	51	P	
United States			DP119S ABA						
C	P	130	W5	40	W	Cb	25	P	
Taiwan			DN893A AB0						
C	P	130	W5	40	W	Ci	25	P	
Asia Pacific			DL852A UUF			Hong Kong		DL852A AB5	
C	P	130	W5	40	D	Cb	25	H	
Asia Pacific			DL840A UUF			Japan		DL840A ABJ	
Australia/New Zealand			DL840A ABG			Korea		DL840A AB1	
Hong Kong			DL840A AB5			Thailand		DL840A AKL	
C	P	130	W5	40	D	Cb	25	P	
Asia Pacific			DL839A UUF			Taiwan		DL841A AB0	
Australia/New Zealand			DL839A ABG			and			
Hong Kong			DL839A AB5			Thailand		DL839A AKL	
Japan			DL839A ABJ			United States		DH904A ABA	
Japan (English)			DL839A ACF						
Korea			DL839A AB1 and DM936A AB1						
C	P	130	W5	40	D	Ci	25	P	
Asia Pacific			DL851A UUF			Hong Kong		DL851A AB5	
C	P	130	W5	40	C	Cb	25	P	
Asia Pacific			DR852P UUF			Korea		DM935A AB1	

Table 1-4
Compaq Presario X1000 Models

All Compaq Presario X1000 models feature:

- TouchPad pointing device
- 8-cell, 4.4-wH Li-Ion battery pack
- 1-year warranty on parts and labor

X1094	P	160	Y5	80	Y	Cb	51	H	
Australia/New Zealand		DR824A ABG							
X1082	P	160	Y5	80	Y	Cb	51	H	
Australia/New Zealand		DR278A ABG							
X1064	P	160	Y5	80	Y	Ci	51	H	
Korea		DN625A AB1							
X1081	P	160	Y5	80	W	Cb	51	H	
Australia/New Zealand		DR277A ABG				Asia Pacific		DR277A UUF	
X1045	P	160	Y5	80	W	Cb	51	H	
Asia Pacific		DN601A UUF				Korea		DN606A AB1	
X1030	P	160	Y5	60	Y	Cb	51	H	
Australia/New Zealand		DN591A ABG							
X1071	P	160	Y5	60	Y	Cb	25	H	
People's Republic of China		DQ977A AB2							
X1046	P	160	Y5	60	W	Cb	51	H	
Korea		DN607A AB1							
X1029	P	160	Y5	60	W	Cb	25	H	
Australia/New Zealand		DN600A ABG							
X1073	P	160	Y5	60	W	Ci	51	H	
Hong Kong		DR269A AB5				Korea		DR269A AB1	

**Table 1-4
Compaq Presario X1000 Models (Continued)**

X1070	P	160	Y5	60	D	Cb	25	H	
People's Republic of China			DQ976A AB2						
X1074	P	160	Y5	60	D	Ci	51	H	
Hong Kong			DR270A AB5						
X1091	P	160	Y5	40	W	Ci	25	H	
Korea			DR287A AB1						
X1093	P	160	W5	80	Y	Cb	51	H	
Australia/New Zealand			DR823A ABG						
X1097	P	160	W5	80	W	Ci	51	H	
Australia/New Zealand			DR824A ABG						
X1140	P	160	W5	60	Y	Cb	51	H	
United Kingdom			DP772E ABU						
X1155	P	160	W5	60	Y	Ci	51	H	
Sweden			DP775E AK8						
X1090	P	160	W5	60	W	Cb	51	H	
Asia Pacific			DR286A UUF						
X1076	P	160	W5	60	W	Cb	51	H	
Asia Pacific			DR272A UUF						
X1066	P	150	Z5	80	Y	Ci	51	H	
Asia Pacific			DN627A UUF						
X1015	P	150	Y5	80	Y	Cb	10	H	
United States			DN624A ABA						
X1086	P	150	Y5	80	Y	Cb	51	H	
Hong Kong			DR282A AB5						

**Table 1-4
Compaq Presario X1000 Models (Continued)**

X1085	P	150	Y5	80	W	Cb	51	H	
Hong Kong			DR281A AB5						
X1056	P	150	Y5	60	Y	Cb	25	H	
People's Republic of China			DN617A AB2						
X1049	P	150	Y5	60	W	Cb	51	H	
Hong Kong			DN610A AB5						
X1023	P	150	Y5	60	W	Cb	51	H	
Asia Pacific			DN584A UUF						
X1069	P	150	Y5	60	W	Cb	25	H	
People's Republic of China			DQ975A AB2						
X1084	P	150	Y5	60	W	Ci	25	H	
Korea			DR280A AB1						
X1055	P	150	Y5	60	D	Cb	25	H	
People's Republic of China			DN616A AB2						
X1040	P	150	W5	80	Y	Cb	51	H	
United States			DM774A ABA						
X1089	P	150	W5	80	W	Cb	51	H	
Taiwan			DR285A AB0						
X1050	P	150	W5	60	Y	Cb	51	H	
Hong Kong			DN611A AB5						
X1020	P	150	W5	60	Y	Cb	51	H	
The Netherlands			DM416A ABH						
X1088	P	150	W5	60	W	Cb	51	H	
Taiwan			DR284A AB0						

**Table 1-4
Compaq Presario X1000 Models (Continued)**

X1079	P	150	W5	60	W	Cb	51	H	
Taiwan			DR275A AB0						
X1044	P	150	W5	60	W	Cb	51	H	
Korea			DN605A AB1						
X1032	P	150	W5	60	W	Cb	51	H	
Asia Pacific			DN593A UUF						
X1058	P	150	W5	60	W	Cb	25	H	
Korea			DN619A AB1						
X1054	P	150	W5	60	W	Cb	25	H	
People's Republic of China			DN615A AB2						
X1010	P	150	W5	40	W	Cb	51	H	
Denmark			DL963A ABY			Spain		DL963A ABE	
Portugal			DL963A AB9			United Kingdom		DL963A ABU	
X1068	P	150	W5	40	W	Cb	25	H	
People's Republic of China			DQ974A AB2						
X1028	P	150	W5	40	W	Cb	25	H	
Asia Pacific			DN589A UUF						
X1067	P	150	W5	40	D	Cb	25	H	
People's Republic of China			DQ973A AB2						
X1020	P	140	Y5	80	Y	Cb	10	P	
United States			DK572A ABA						
X1063	P	140	Y5	60	W	Cb	25	H	
People's Republic of China			DN623A AB2						

**Table 1-4
Compaq Presario X1000 Models (Continued)**

X1022	P	140	Y5	60	W	Cb	25	H	
Asia Pacific			DN583A UUF						
X1065	P	140	Y5	60	W	Ci	25	H	
Asia Pacific			DN626A UUF						
X1048	P	140	Y5	40	W	Cb	25	H	
Hong Kong			DN609A AB5						
X1083	P	140	Y5	40	W	Ci	25	H	
Asia Pacific			DR279A UUF			Korea		DR279A AB1	
X1095	P	140	Y5	40	C	Cb	25	H	
Asia Pacific			DR825A UUF						
X1028	P	140	W5	80	Y	Cb	51	P	
United States			DL898A ABA						
X1037	P	140	W5	60	W	Cb	51	H	
Thailand			DN598A AKL						
X1036	P	140	W5	60	W	Cb	51	H	
Taiwan			DN597A AB0						
X1018	P	140	W5	60	W	Cb	51	H	
United States			DK574A ABA						
X1010	P	140	W5	60	W	Cb	51	H	
Canada (English)			DL857A ABL			French Canada		DL857A ABC	
X1007	P	140	W5	60	W	Cb	51	H	
Sweden/Finland			DL964A AK8						
X1001	P	140	W5	60	W	Cb	51	H	
United States			DK575A ABA						

**Table 1-4
Compaq Presario X1000 Models (Continued)**

X1057	P	140	W5	60	W	Cb	25	H		
Korea			DN618A AB1							
X1053	P	140	W5	60	W	Cb	25	H		
People's Republic of China			DN614A AB2							
X1092	P	140	W5	60	W	Ci	25	H		
Korea			DR822A AB1							
X1087	P	140	W5	60	D	Cb	51	H		
Taiwan			DR283A AB0							
X1078	P	140	W5	60	D	Cb	51	H		
Taiwan			DR274A AB0							
X1043	P	140	W5	40	Y	Cb	51	H		
Korea			DN604A AB1							
X1016	P	140	W5	40	Y	Cb	51	H		
France			DM415A ABF			Italy			DM415A ABZ	
X1110	P	140	W5	40	W	Cb	51	H		
Sweden			DP773E AK8							
X1080	P	140	W5	40	W	Cb	51	H		
Thailand			DR276A AKL							
X1062	P	140	W5	40	W	Cb	51	H		
Asia Pacific			DN622A UUF							
X1030	P	140	W5	40	W	Cb	51	H		
United States			DM773A ABA							
X1012	P	140	W5	40	W	Cb	51	H		
France			DL965A ABF							

**Table 1-4
Compaq Presario X1000 Models (Continued)**

X1105	P	140	W5	40	W	Cb	25	H	
United Kingdom			DP771E ABU						
X1077	P	140	W5	40	W	Cb	25	H	
Taiwan			DR273A AB0						
X1075	P	140	W5	40	W	Cb	25	H	
Asia Pacific			DR271A UUF						
X1052	P	140	W5	40	W	Cb	25	H	
People's Republic of China			DN613A AB2						
X1050	P	140	W5	40	W	Cb	25	H	
Canada English French Canada			DP485U ABL DP485U ABC			United States		DM777A ABA	
X1042	P	140	W5	40	W	Cb	25	H	
Korea			DN603A AB1						
X1002	P	140	W5	40	W	Cb	25	H	
United States			DM771A ABA						
X1115	P	140	W5	40	W	Ci	51	H	
Sweden			DP774E AK8						
X1096	P	140	W5	40	W	Ci	25	H	
Asia Pacific			DR826A UUF			Taiwan		DR826A AB0	
X1051	P	140	W5	40	D	Cb	25	H	
People's Republic of China			DN612A AB2						
X1072	P	140	W5	30	W	Cb	25	H	
Hong Kong			DR268A AB5						
X1021	P	130	Y5	40	D	Cb	25	H	
Asia Pacific			DN582A UUF						

**Table 1-4
Compaq Presario X1000 Models (Continued)**

X1038	P	130	W5	60	W	Cb	51	H	
Thailand			DN599A AKL						
X1010	P	130	W5	60	W	Cb	51	H	
United States			DK571A ABA						
X1035	P	130	W5	60	D	Cb	51	H	
Taiwan			DN596A AB0						
X1006	P	130	W5	40	Y	Cb	51	H	
France			DM933A ABF						
X1060	P	130	W5	40	W	Cb	51	H	
Thailand			DN620A AKL						
X1012	P	130	W5	40	W	Cb	51	H	
United States			DN585A ABA						
X1061	P	130	W5	40	W	Cb	25	H	
Asia Pacific			DN621A UUF						
X1047	P	130	W5	40	W	Cb	25	H	
Hong Kong			DN608A AB5						
X1041	P	130	W5	40	W	Cb	25	H	
Korea			DN602A AB1						
X1031	P	130	W5	40	W	Cb	25	H	
Asia Pacific			DN592A UUF						
X1005	P	130	W5	40	W	Cb	25	H	
Belgium			DL681A UUG			The Netherlands		DL681A ABH	
Denmark			DL681A ABY			Portugal		DL681A AB9	
France			DL681A ABF			Spain		DL681A ABE	
Italy			DL681A ABZ			Sweden/Finland		DL681A AK8	
Latin America			DL858A ABM			United Kingdom		DL681A ABU	

**Table 1-4
Compaq Presario X1000 Models (Continued)**

X1034	P	130	W5	40	D	Cb	25	H	
Taiwan			DN595A AB0						
X1033	P	130	W5	40	D	Cb	25	H	
Asia Pacific			DN594A UUF			Thailand		DN594A AKL	
X1027	P	130	W5	40	D	Cb	25	H	
Australia/New Zealand			DN588A ABG						
X1040	P	130	W5	40	C	Cb	25	H	
Korea			DN601A AB1						
X1026	P	130	W5	40	C	Cb	25	H	
Asia Pacific			DN587A UUF			Thailand		DN587A AKL	
Australia/New Zealand			DN587A ABG						

1.2 Features

- Mobile Intel Pentium 4 Processor-M 1.7-, 1.6-, 1.5-, 1.4-, or 1.3-GHz processors with 400-MHz processor side bus and 512-KB L2 cache, varying by notebook model
- 15.4-inch wide UXGA (1920 × 1200), wide SXGA+ (1680 × 1050), or wide XGA (1280 × 800) TFT display with over 16.7 million colors, varying by notebook model
- ATI MOBILITY RADEON graphics with 32- or 64-MB DDR SDRAM
- 80-, 60-, or 40-GB high-capacity hard drive, varying by notebook model
- 256-MB high-performance synchronous DRAM (SDRAM), expandable to 2.0 GB
- Windows XP Home or Windows XP Pro, varying by notebook model
- Full-size Windows 98 keyboard
- TouchPad pointing device with on/off button and dedicated scroll up/down surface
- 56-Kbps V.92 modem integrated on the system board
- Integrated Secure Digital (SD) flash media slot
- Integrated 10/100 network interface card (NIC)
- Integrated wireless support for Mini PCI 802.11 a/b/g and Bluetooth[®] local area network (LAN) devices
- Support for one Type II PC Card slot with support for both 32-bit (CardBus) and 16-bit PC Cards
- External 65-watt AC adapter with power cord
- 8-cell Li-Ion battery pack
- Harman/Kardon speakers (HP Pavilion zt3000 models only)

- JBL Pro speakers (HP Compaq nx7000 and Compaq Presario X1000 models only)
- Support for the following optical drives:
 - ❑ 24X Max DVD/CD-RW combo drive
 - ❑ 8X Max DVD-RW drive
 - ❑ 24X Max CD-ROM drive
- Connectors for:
 - ❑ Microphone
 - ❑ Stereo speaker/headphone
 - ❑ Infrared
 - ❑ DC power
 - ❑ External monitor
 - ❑ S-Video
 - ❑ USB (3)
 - ❑ RJ-45 (network interface card, [NIC])
 - ❑ RJ-11 (modem)
 - ❑ Parallel
 - ❑ 1394 digital
 - ❑ One Type II PC Card slot
 - ❑ Docking

1.3 Clearing a Password

If the notebook you are servicing has an unknown password, follow these steps to clear the password. These steps also clear CMOS:

1. Prepare the notebook for disassembly (refer to Section 5.3, “Preparing the Notebook for Disassembly,” for more information).
2. Remove the real time clock (RTC) battery (refer to Section 5.7, “RTC Battery”).
3. Wait approximately five minutes.
4. Replace the RTC battery and reassemble the notebook.
5. Connect AC power to the notebook. Do **not** reinsert the battery pack at this time.
6. Turn on the notebook.

All passwords and all CMOS settings have been cleared.

1.4 Power Management

The notebook comes with power management features that extend battery operating time and conserve power. The notebook supports the following power management features:

- Standby
- Hibernation
- Setting customization by the user
- Hotkeys for setting level of performance
- Battery calibration
- Lid switch Standby/resume
- Power/Standby button
- Advanced Configuration and Power Management (ACP) compliance

1.5 External Components

The external components on the front and left-side of the notebook are shown in the following illustration and described in Table 1-5.

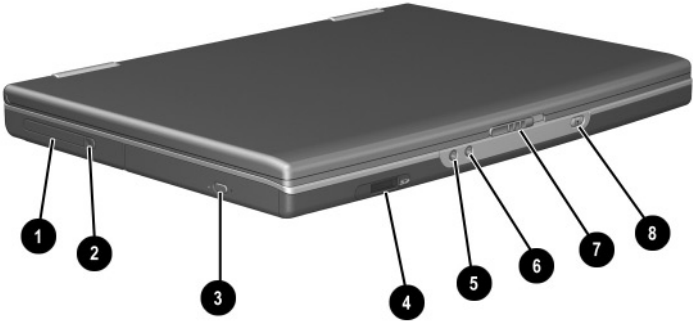

Front and Left-Side Components

Table 1-5
Front and Left-Side Components

Item	Component	Function
1	PC Card slot	Supports an optional Type I or Type II 32-bit (CardBus) or 16-bit PC Card.
2	PC Card eject button	Ejects an optional PC Card from the PC Card slot.
3	Optical drive	Supports an optical disc.
4	SD (Secure Digital) Memory Card slot	Supports SD Cards and MultiMediaCards.
5	Microphone jack	Connects an optional monaural or stereo microphone.
6	Audio line-out jack	Connects optional headphone or powered stereo speakers. Also connects the audio function of an audio/video device such as a television or VCR.
7	Display release latch	Opens the notebook.
8	Wireless device button	Turns an optional internal wireless device on or off.

The notebook rear panel and right-side components are shown in the following illustration and described in Table 1-6.

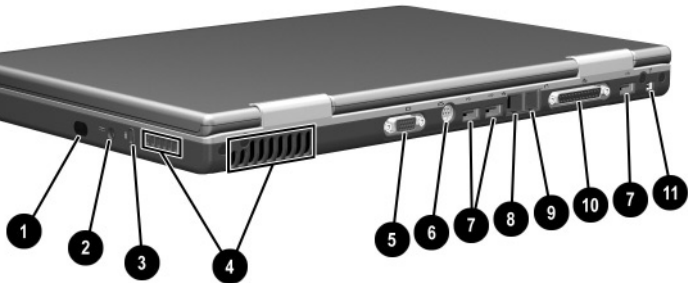



Rear Panel and Right-Side Components

**Table 1-6
Rear Panel and Right-Side Components**

Item	Component	Function
1	Infrared port	Provides wireless communication between the notebook and an optional IrDA-compliant device.
2	Power connector	Connects an AC adapter cable.

Table 1-6
Rear Panel and Right-Side Components (*Continued*)

Item	Component	Function
3	Security cable slot	Attaches an optional security cable to the notebook.  The purpose of security solutions is to act as a deterrent. These solutions do not prevent the product from being mishandled or stolen.
4	Vents (2)	Allow airflow to cool internal components.  To prevent overheating, use the notebook only on hard surfaces which cannot obstruct the vents. Do not allow a soft surface, such as bedding, clothing, or a thick rug, to block airflow.
5	External monitor connector	Connects an optional VGA external monitor or projector.
6	S-Video connector	Connects an optional S-Video device, such as a television, VCR, camcorder, projector, or video capture card.
7	USB connectors (3)	Connect optional 2.0-compliant USB devices.
8	RJ-45 network jack	Connects an Ethernet network cable.
9	RJ-11 telephone jack	Connects a modem cable.
10	Parallel connector	Connects an optional parallel device such as a printer.
11	1394 connector	Connects an optional 1394 device such as a camcorder or digital camera.

The notebook keyboard components are shown in the following illustration and described in Table 1-7.



Keyboard Components

Table 1-7
Keyboard Components

Item	Component	Function
1	F1 through F12 function keys	Perform system and application tasks. When combined with the Fn key, the function keys F1 and F3 through F12 perform additional tasks as hotkeys.
2	num lk key	Enables numeric lock and the internal keypad.
3	Internal keypad	Can be used like the keys on an external numeric keypad.
4	Cursor control keys	Move the cursor around the screen.
5	Applications key	Displays a shortcut menu for items beneath the pointer.
6	Windows logo key	Display the Windows Start menu.
7	Fn key	Executes frequently used system functions when pressed in combination with another key.

The notebook top components are shown in the following illustration and described in Table 1-8.

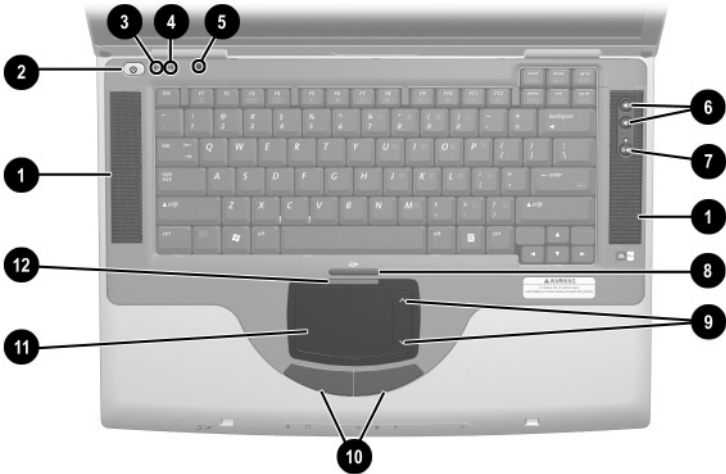

Top Components

Table 1-8
Top Components

Item	Component	Function
1	Stereo speakers (2)	Produce stereo sound.
2	Power button	When the notebook is: <ul style="list-style-type: none">■ Off, press to turn on the notebook.■ On, briefly press to initiate Hibernation.■ In Standby, briefly press to resume from Standby.■ In Hibernation, briefly press to restore from Hibernation.

Table 1-8
Top Components (Continued)

Item	Component	Function
3	Caps lock light	On: Caps lock is on.
4	Num lock light	On: Num lock or the internal keypad is on.
5	Display lid switch	<ul style="list-style-type: none"> ■ If the notebook is closed while on, turns off the display. ■ If the notebook is opened while in Standby, turns on the notebook (resumes from Standby).
6	Volume buttons (2)	Increase or decrease system volume.
7	Mute button	Mutes or restores volume.
8	TouchPad on/off button	Enables/disables the TouchPad.
9	TouchPad scroll zones (2)	Scroll upward or downward.
10	Left and right TouchPad buttons	Function like the left and right buttons on an external mouse.
11	TouchPad	Moves the pointer and selects or activates items on the screen.
12	TouchPad light	On: TouchPad is enabled.

The external components on the bottom of the notebook are shown in the following illustration and described in Table 1-9.

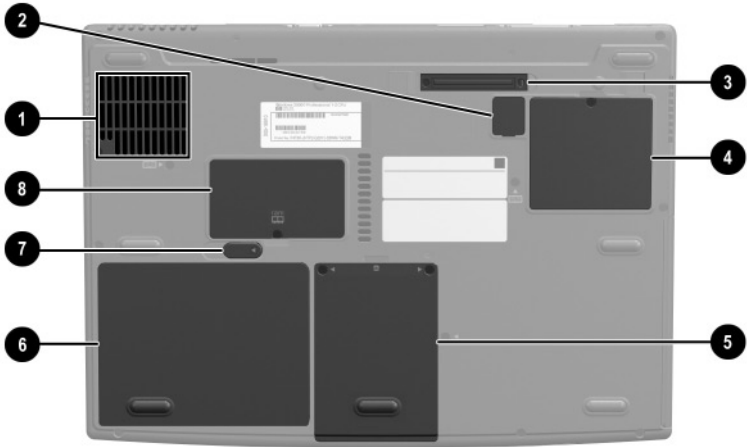

Bottom Components

**Table 1-9
Bottom Components**

Item	Component	Function
1	Fan vent	Allows airflow to cool internal components. △ To prevent overheating, do not obstruct the vent. Using the notebook on a soft surface, such as a pillow, blanket, rug, or thick clothing, may block airflow.
2	RTC battery compartment	Contains the RTC battery.

Table 1-9
Bottom Components (Continued)

Item	Component	Function
3	Docking connector	Connects the notebook to an optional port replicator.
4	Mini PCI compartment	Contains the Mini PCI wireless card.
5	Hard drive bay	Holds the internal hard drive.
6	Battery bay	Holds the battery pack.
7	Battery pack release latch	Releases a battery pack from the battery bay.
8	Memory expansion compartment	Contains one memory slot for an optional 128-, 256-, 512-, or 1024-MB memory module.

1.6 Design Overview

This section presents a design overview of key parts and features of the notebook. Refer to Chapter 3, “Illustrated Parts Catalog,” to identify replacement parts, and Chapter 5, “Removal and Replacement Procedures,” for disassembly steps. The system board provides the following device connections:

- Memory expansion board
- Hard drive
- Display
- Keyboard and TouchPad
- Audio
- Mobile Intel Pentium 4 Processor-M processors
- Fan
- PC Card
- Modem, NIC, and wireless devices



CAUTION: To properly ventilate the notebook, allow at least a 7.6-cm (3-inch) clearance on the left and right sides of the notebook.

The notebook uses an electric fan for ventilation. The fan is controlled by a temperature sensor and is designed to turn on automatically when high temperature conditions exist. These conditions can be caused by high external temperatures, heavy system power consumption, certain power management/battery conservation configurations, battery fast charging, and some software applications. Exhaust air is displaced through the ventilation grill located on the left side of the notebook.

Troubleshooting



WARNING: Only authorized technicians trained by HP should repair this equipment. All troubleshooting and repair procedures are detailed to allow only subassembly/module level repair. Because of the complexity of the individual boards and subassemblies, do not attempt to make repairs at the component level or modifications to any printed wiring board. Improper repairs can create a safety hazard. Any indication of component replacement or printed wiring board modification may void any warranty or exchange allowances.

2.1 Computer Setup and Diagnostics Utilities

The notebook features two system management utilities:

- **Computer Setup**—A system information and customization utility that can be used even when your operating system is not working or will not load. This utility includes settings that are not available in Microsoft® Windows®.

- **Diagnostics for Windows**—A system information and diagnostic utility that is used within the Windows operating system. Use this utility whenever possible to:
 - ❑ Display system information.
 - ❑ Test system components.
 - ❑ Troubleshoot a device configuration problem in Windows XP Professional or Windows XP Home.



It is not necessary to configure a device connected to a USB connector on the notebook or to an optional port replicator.

Using Computer Setup

Information and settings in Computer Setup are accessed from the File, Security, or Advanced menus:

1. Turn on or restart the notebook. Press **F10** while the F10 = ROM-Based Setup message is displayed in the lower left corner of the screen.
 - ❑ To change the language, press **F2**.
 - ❑ To view navigation information, press **F1**.
 - ❑ To return to the Computer Setup menu, press **esc**.
2. Select the File, Security, or Advanced menu.
3. To close Computer Setup and restart the notebook:
 - ❑ Select File > Save Changes and Exit and press **enter**.
 - or-
 - ❑ Select File > Ignore Changes and Exit and press **enter**.
4. When you are prompted to confirm your action, press **F10**.



Selecting from the File Menu

**Table 2-1
File Menu**

Select	To Do This
System Information	<ul style="list-style-type: none"> ■ View identification information about the notebook, a port replicator, and any battery packs in the system. ■ View specification information about the processor, memory and cache size, and system ROM.
Save to Floppy	Save system configuration settings to a diskette.
Restore from Floppy	Restore system configuration settings from a diskette.
Restore Defaults	Replace configuration settings in Computer Setup with factory default settings. Identification information is retained.
Ignore Changes and Exit	Cancel changes entered during the current session, then exit and restart the notebook.
Save Changes and Exit	Save changes entered during the current session, then exit and restart the notebook.

Selecting from the Security Menu

Table 2-2
Security Menu

Select	To Do This
Administrator Password	Enter, change, or delete an administrator password.
Power-on Password	Enter, change, or delete a power-on password.
DriveLock Passwords	Enable/disable DriveLock; change a DriveLock User or Master password.  DriveLock Settings are accessible only when you enter Computer Setup by turning on (not restarting) the notebook.
Device Security	Enable/disable: <ul style="list-style-type: none">■ Ports■ Diskette write*■ CD-ROM or diskette startup  Settings for a DVD-ROM can be entered in the CD-ROM field.
System IDs	Enter identification numbers for the notebook, a port replicator, and all battery packs in the system.

Selecting from the Advanced Menu

**Table 2-3
Advanced Menu**

Select	To Do This
Language	Change the Computer Setup language.
Boot Options	<p>Enable/disable:</p> <ul style="list-style-type: none"> ■ QuickBoot, which starts the notebook more quickly by eliminating some startup tests. (If you suspect a memory failure and want to test memory automatically during startup, disable QuickBoot.) ■ MultiBoot, which sets a startup sequence that can include most bootable devices and media in the system.
Device Options	<ul style="list-style-type: none"> ■ Enable/disable the embedded numeric keypad at startup. ■ Enable/disable multiple standard pointing devices at startup. (To set the notebook to support only a single, usually nonstandard, pointing device at startup, select Disable.) ■ Enable/disable USB legacy support for a USB keyboard. (When USB legacy support is enabled, the keyboard works even when a Windows operating system is not loaded.) ■ Set an optional external monitor or overhead projector connected to a video card in a port replicator as the primary device. (When the notebook display is set as secondary, the notebook must be shut down before it is undocked from a port replicator.)

Table 2-3
Advanced Menu (*Continued*)

Select	To Do This
Device Options (<i>continued</i>)	<ul style="list-style-type: none"> ■ Change the parallel port mode from Enhanced Parallel Port (EPP, the default setting) to standard, bidirectional EPP, or Enhanced Capabilities Port (ECP). ■ Set video-out mode to NTSC (default), PAL, NTSC-J, or PAL-M.* ■ Enable/disable all settings in the SpeedStep[®] window. (When Disable is selected, the notebook runs in Battery Optimized mode.) ■ Specify how the notebook recognizes multiple identical port replicators that are identically equipped. Select Disable to recognize the port replicators as a single port replicator; select Enable to recognize the port replicators individually, by serial number. ■ Enable/disable the reporting of the processor serial number by the processor to the software.

*Video modes vary even within regions. However, NTSC is common in North America; PAL, in Europe, Africa, and the Middle East; NTSC-J, in Japan; and PAL-M, in Brazil. Other South and Central American regions can use NTSC, PAL, or PAL-M.

2.2 Troubleshooting Flowcharts

Table 2-4
Troubleshooting Flowcharts Overview

Flowchart	Description
2.1	Initial troubleshooting
2.2	No power, part 1
2.3	No power, part 2
2.4	No power, part 3
2.5	No power, part 4
2.6	No video, part 1
2.7	No video, part 2
2.8	Nonfunctioning port replicator
2.9	No operating system (OS) loading
2.10	No OS loading from hard drive, part 1
2.11	No OS loading from hard drive, part 2
2.12	No OS loading from hard drive, part 3
2.13	No OS loading from CD- or DVD-ROM drive
2.14	No audio, part 1
2.15	No audio, part 2
2.16	Nonfunctioning device
2.17	Nonfunctioning keyboard
2.18	Nonfunctioning pointing device
2.19	No network or modem connection

Flowchart 2.1 – Initial Troubleshooting

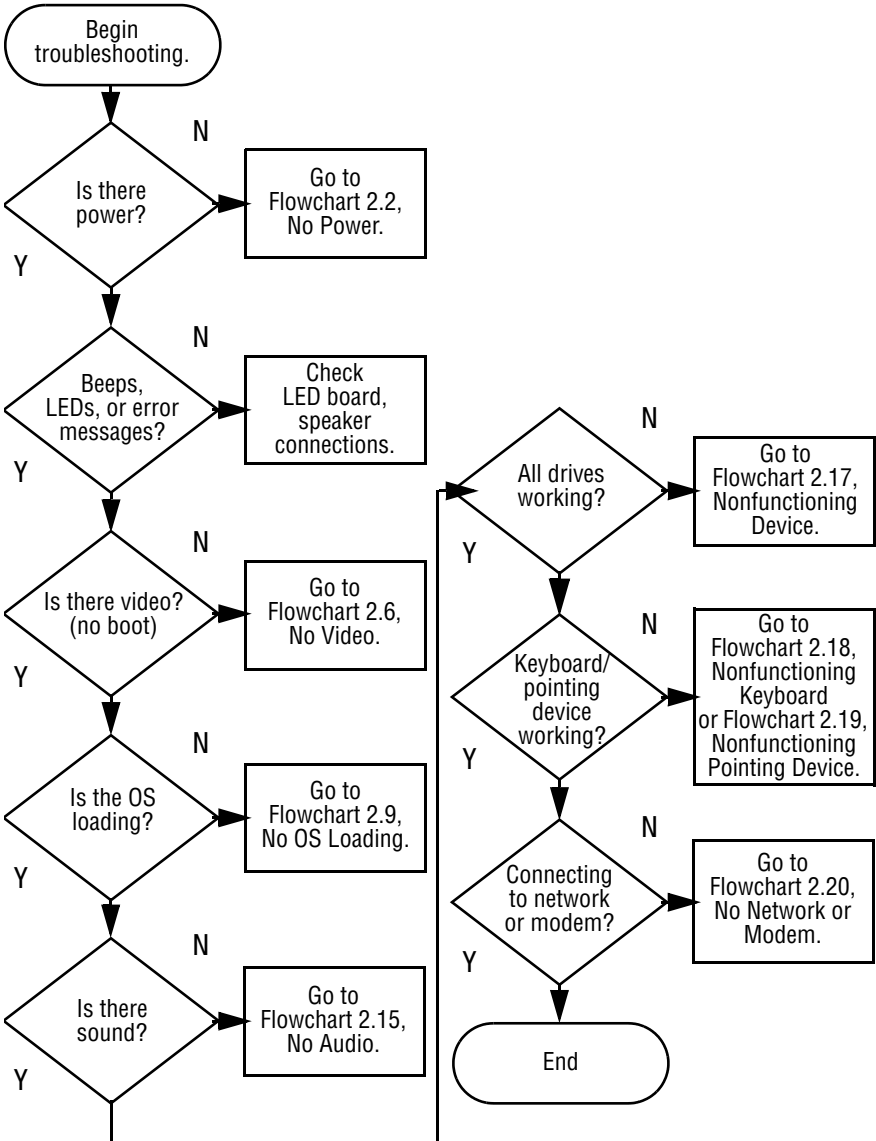

Flowchart 2.2—No Power, Part 1

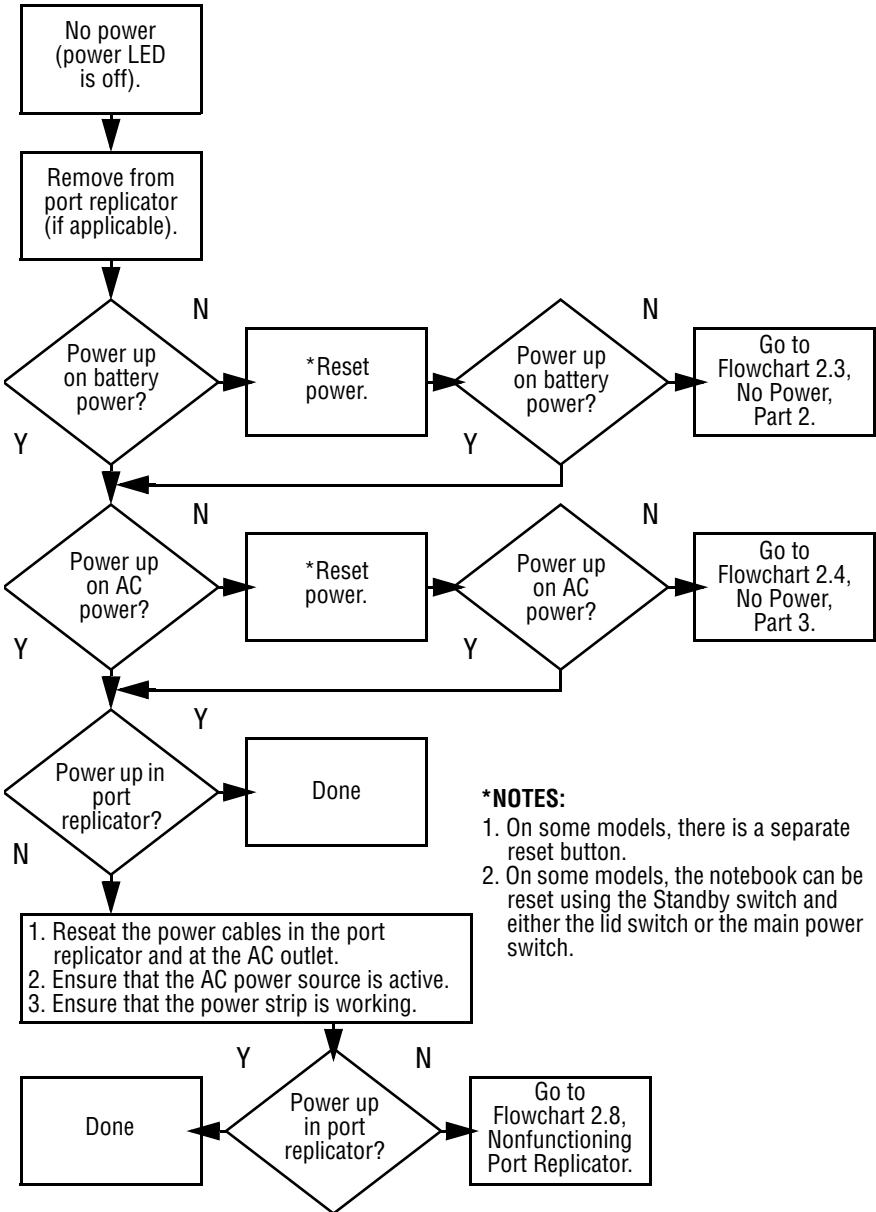

Flowchart 2.3—No Power, Part 2

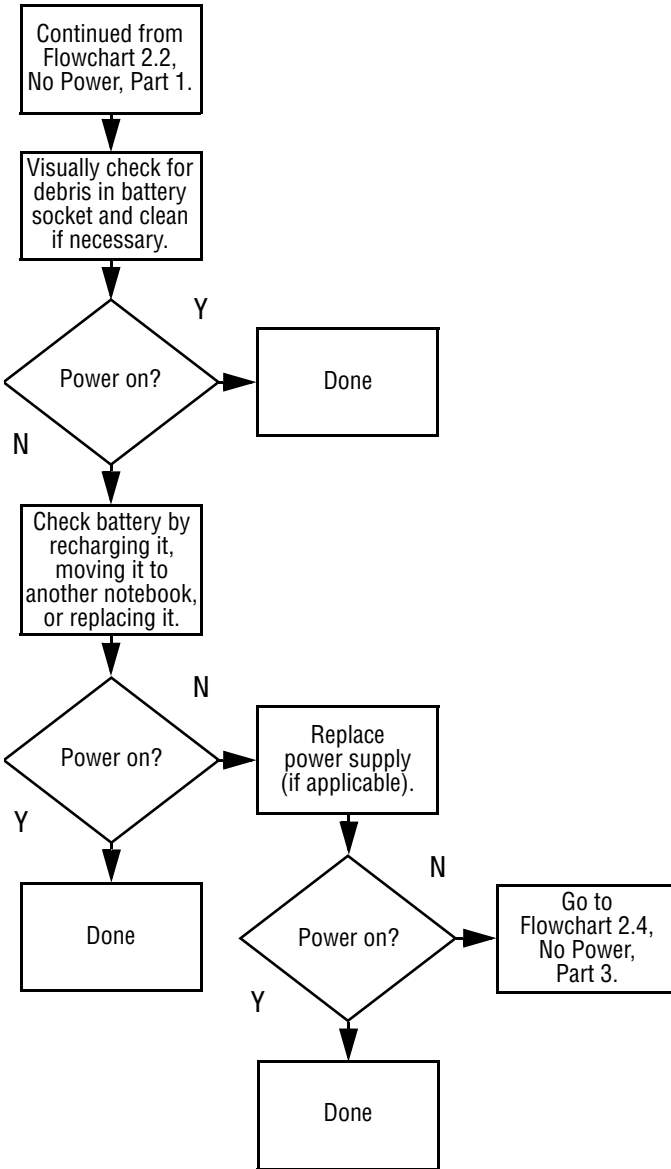

Flowchart 2.4—No Power, Part 3

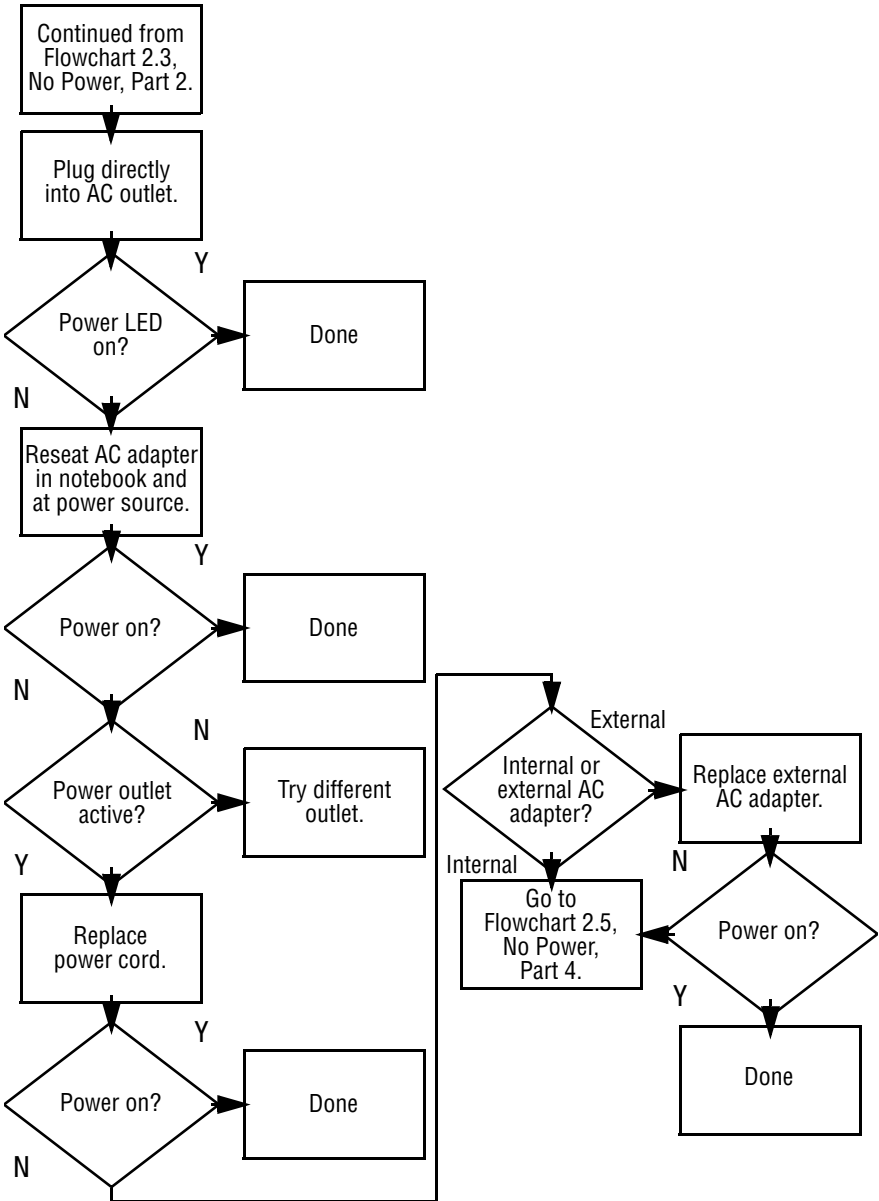

Flowchart 2.5—No Power, Part 4

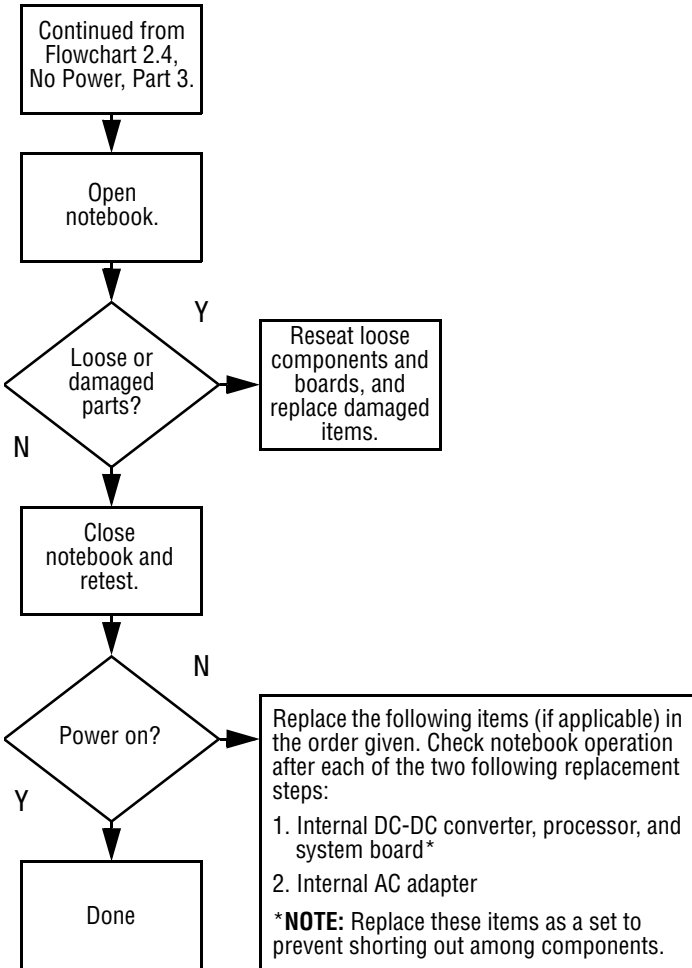

Flowchart 2.6—No Video, Part 1

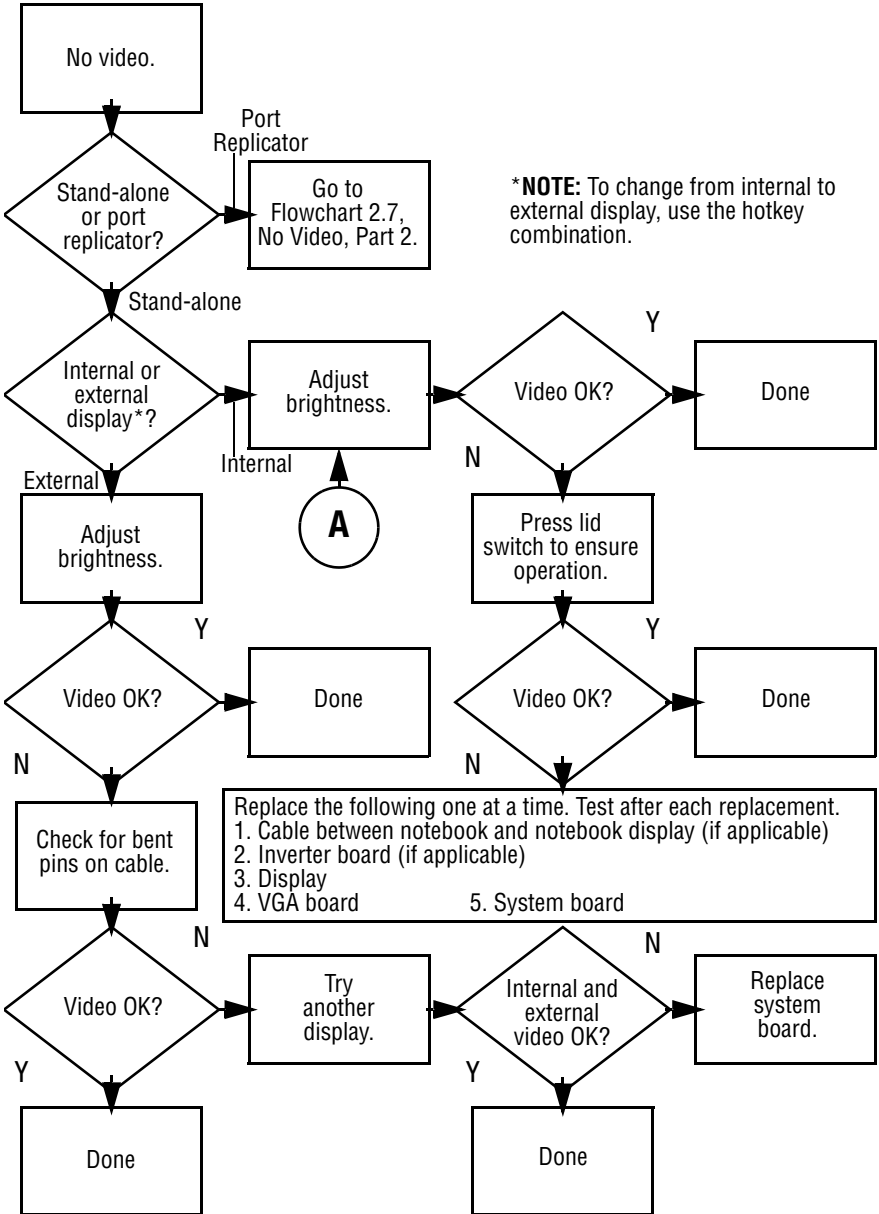

Flowchart 2.7—No Video, Part 2

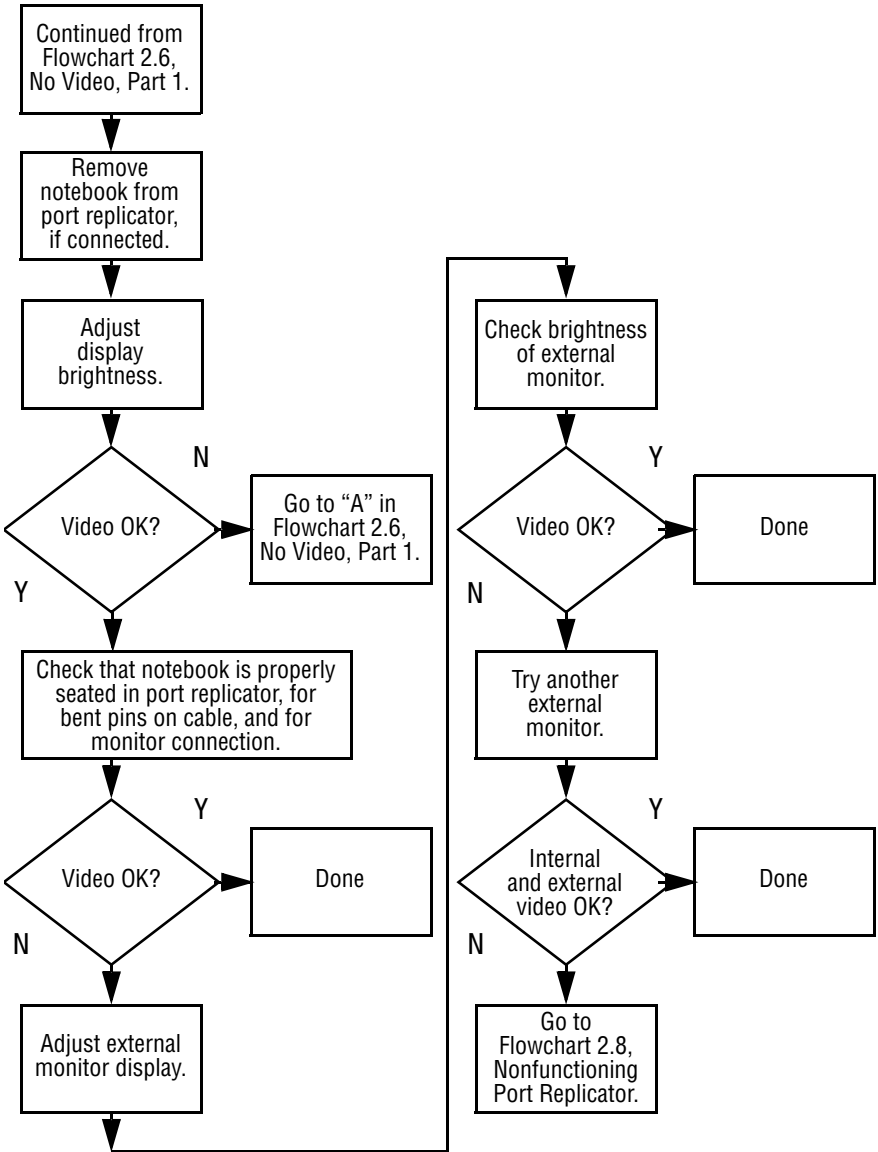

Flowchart 2.8—Nonfunctioning Port Replicator (if applicable)

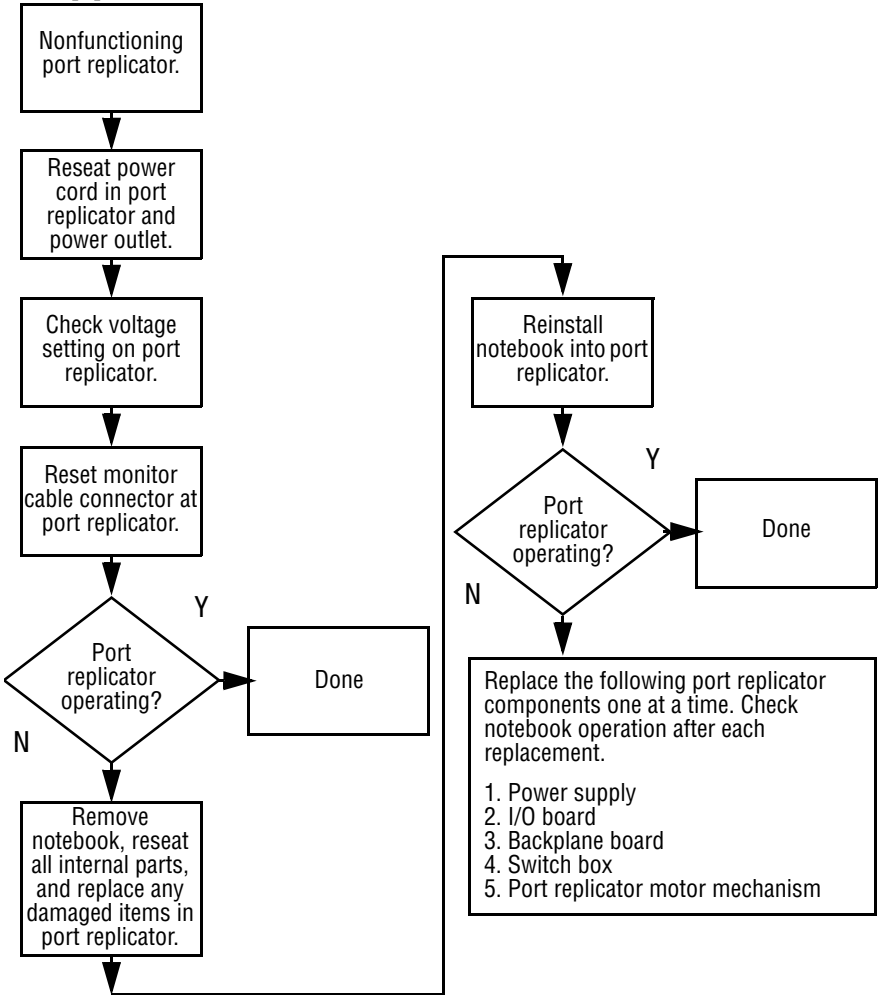

Flowchart 2.9—No Operating System (OS) Loading

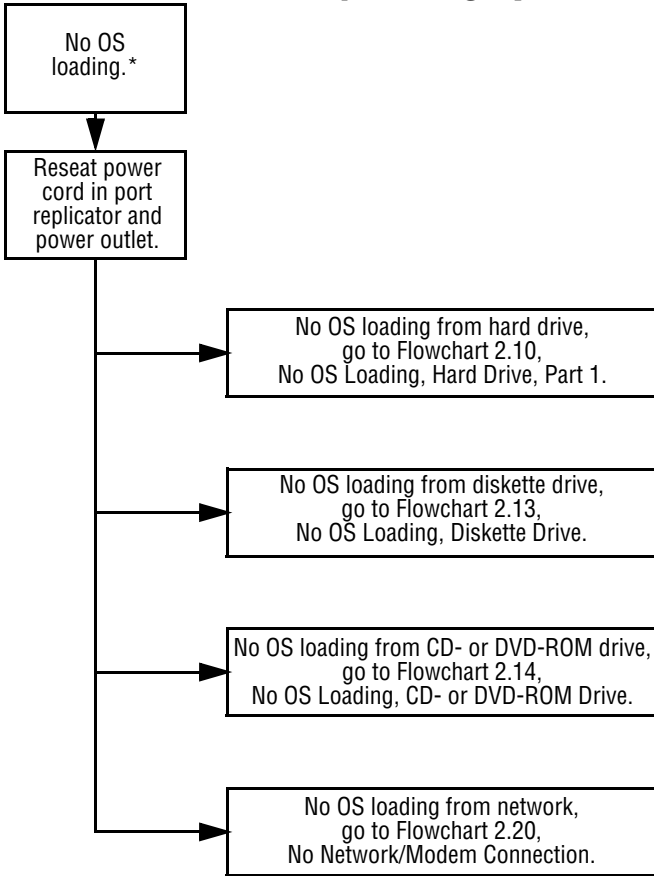

***NOTE:** Before beginning troubleshooting, always check cable connections, cable ends, and drives for bent or damaged pins.

Flowchart 2.10—No OS Loading, Hard Drive, Part 1

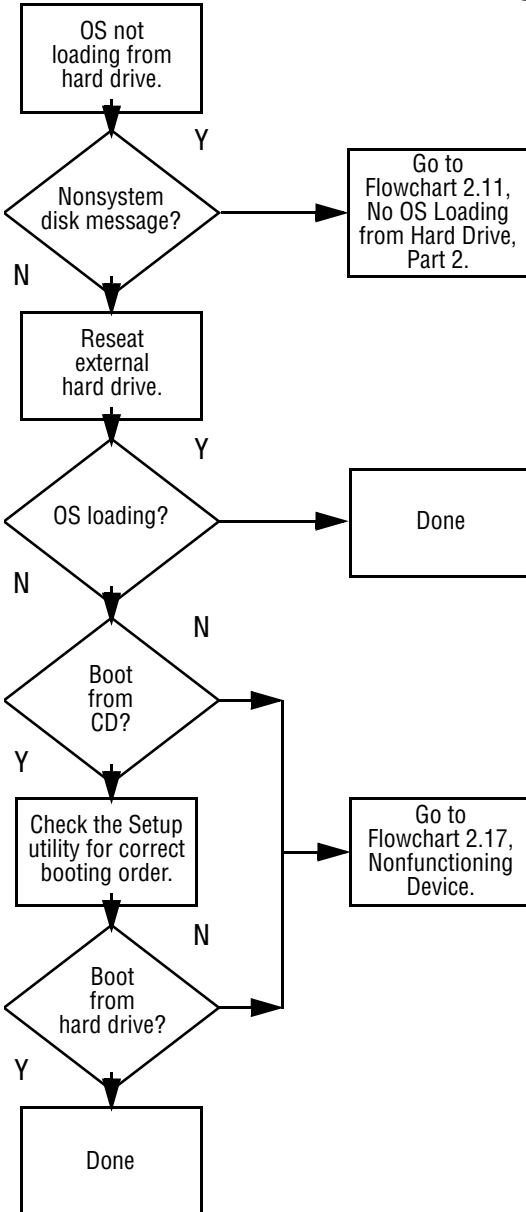

Flowchart 2.11—No OS Loading, Hard Drive, Part 2

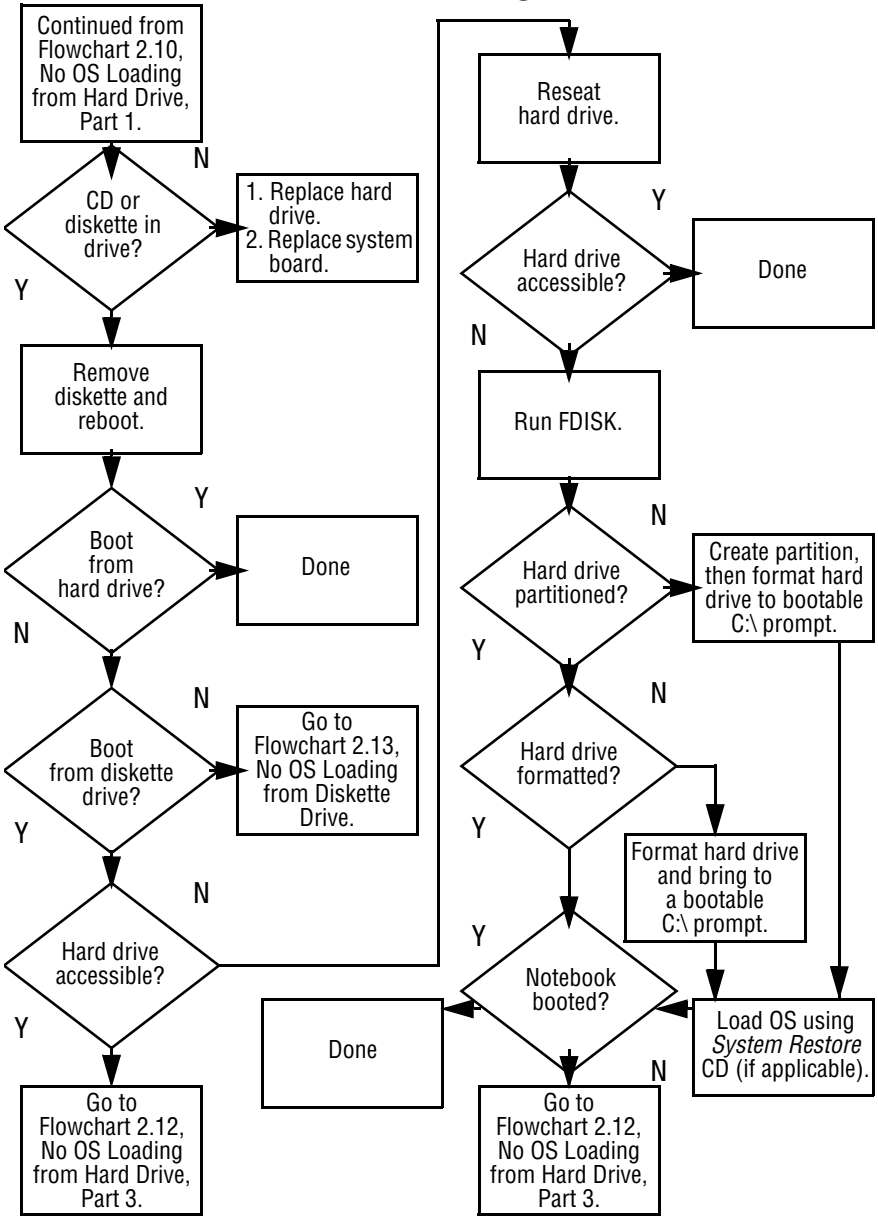

Flowchart 2.12—No OS Loading, Hard Drive, Part 3

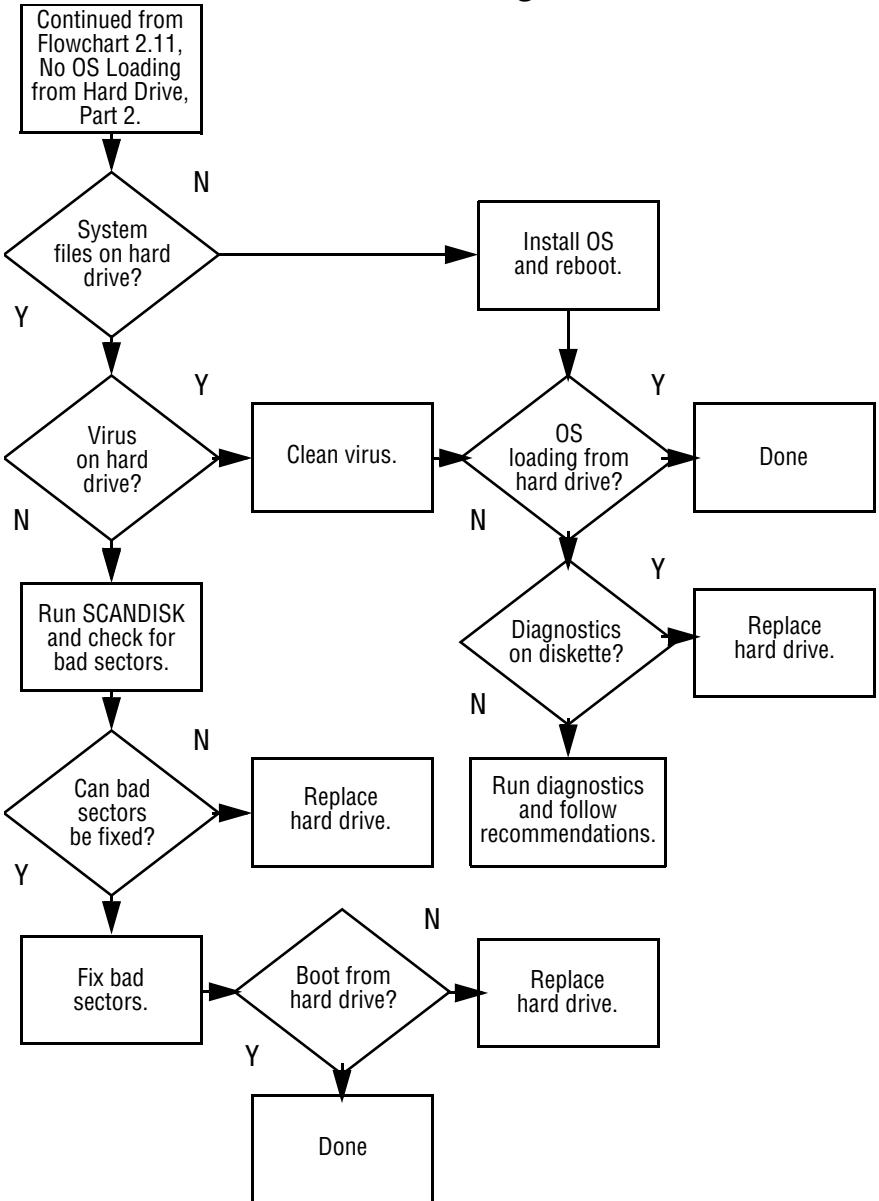

Flowchart 2.13—No OS Loading, CD- or DVD-ROM Drive

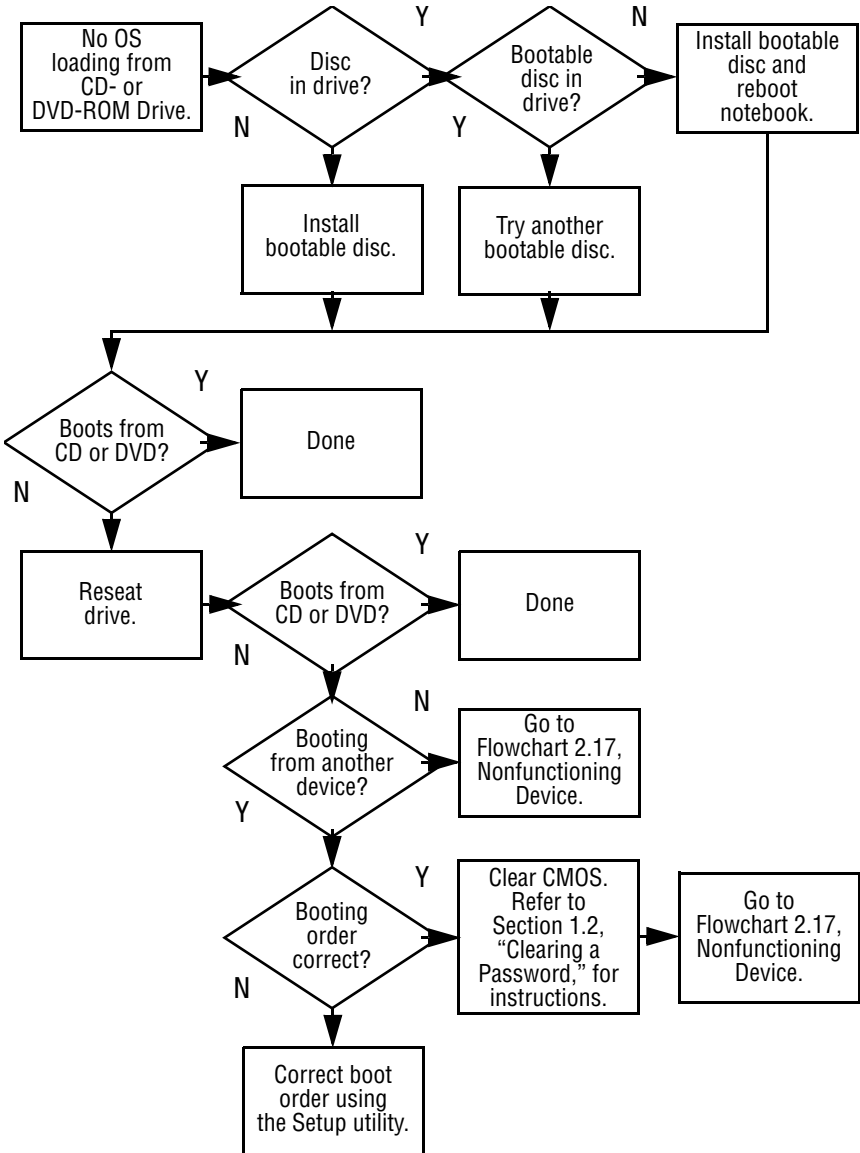

Flowchart 2.14—No Audio, Part 1

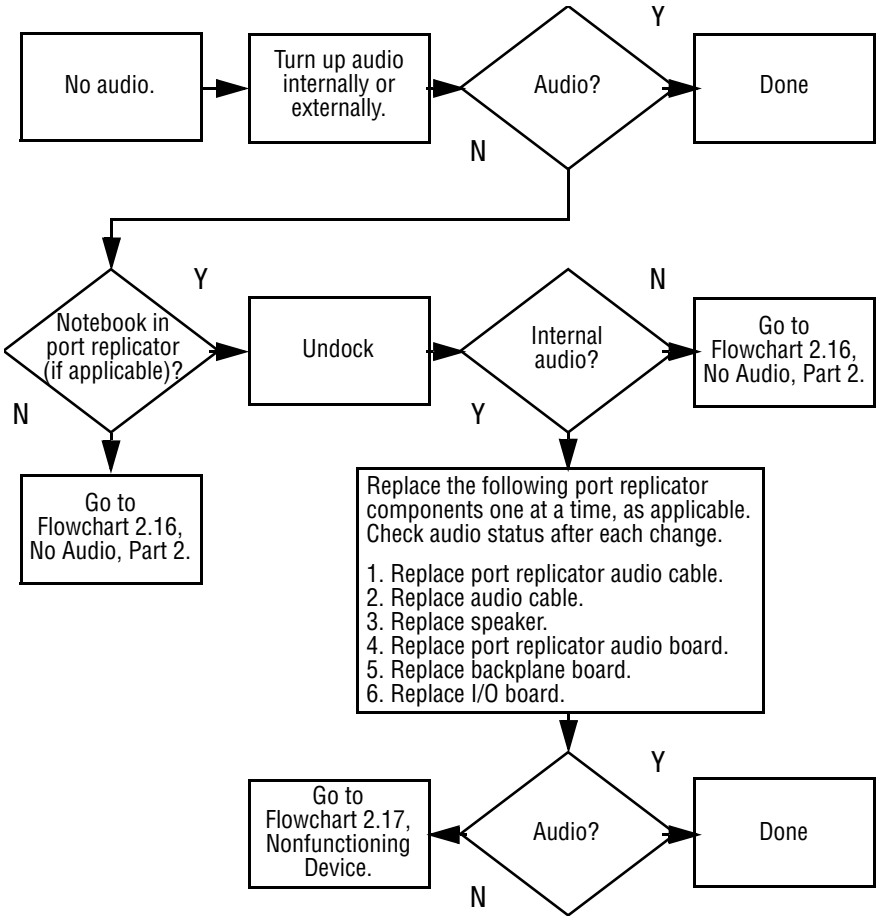

Flowchart 2.15—No Audio, Part 2

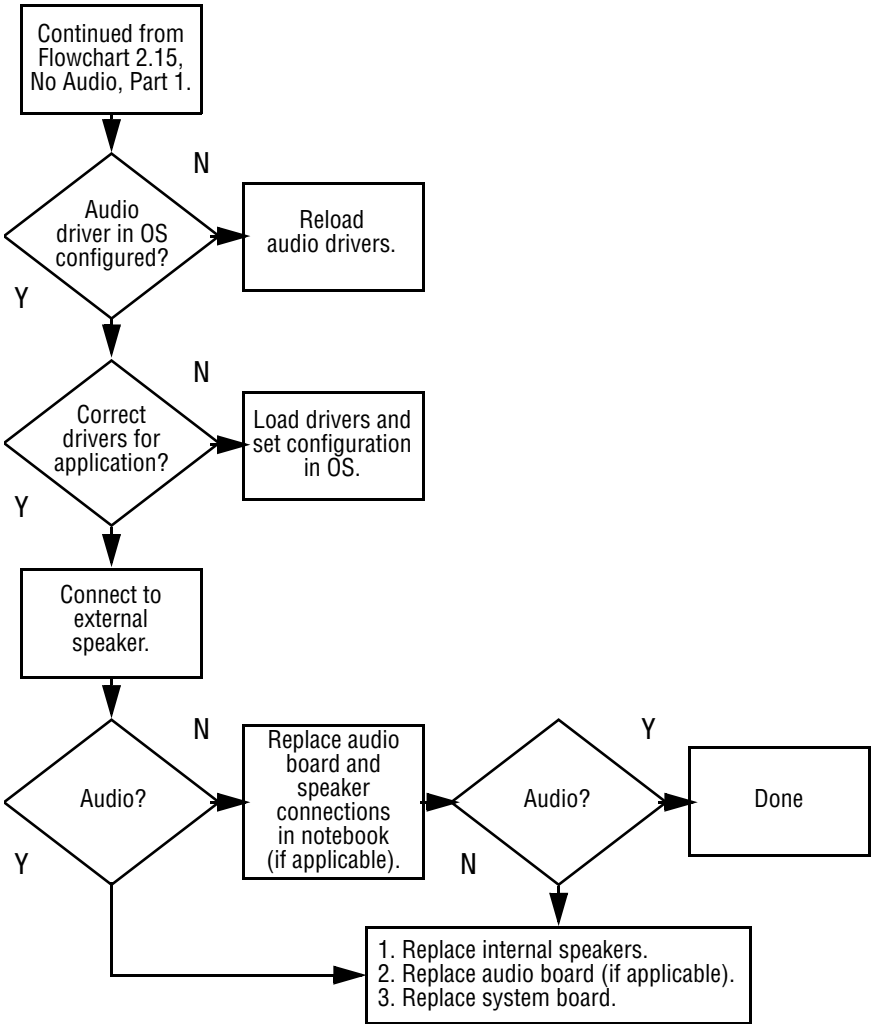

Flowchart 2.16—Nonfunctioning Device

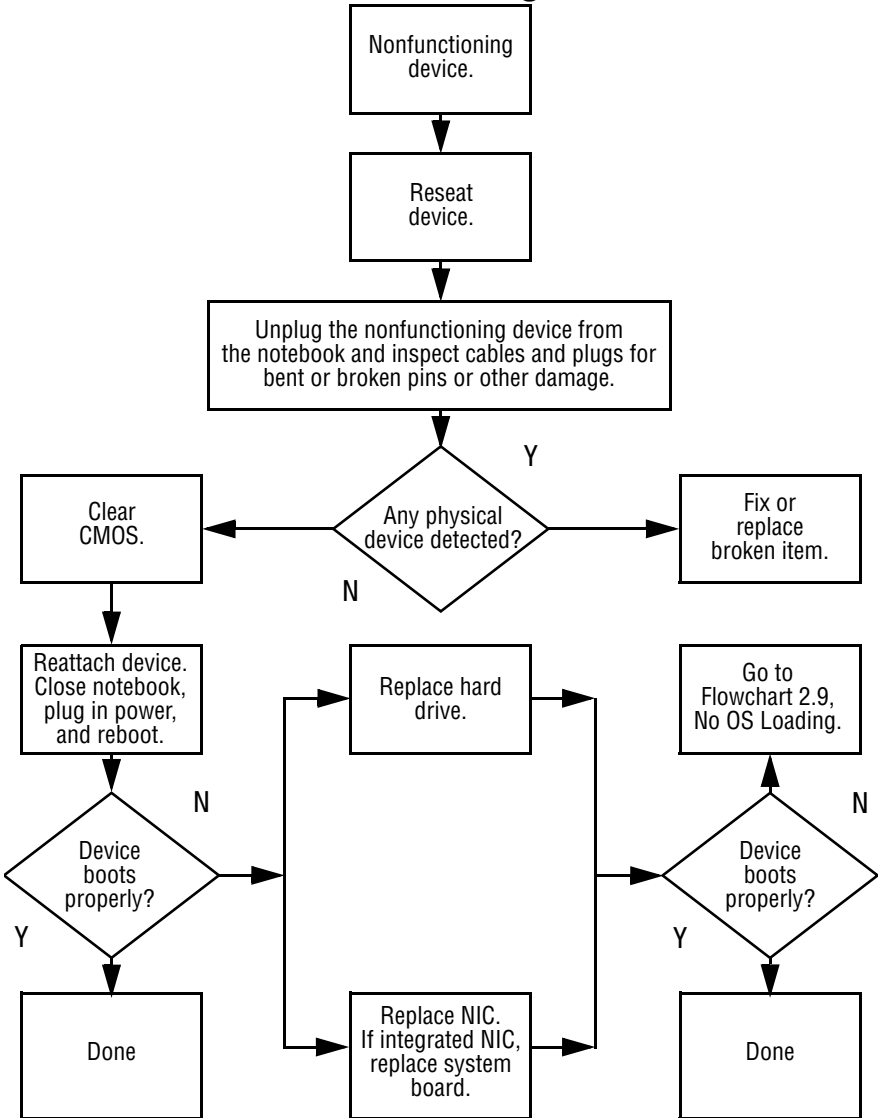

Flowchart 2.17—Nonfunctioning Keyboard

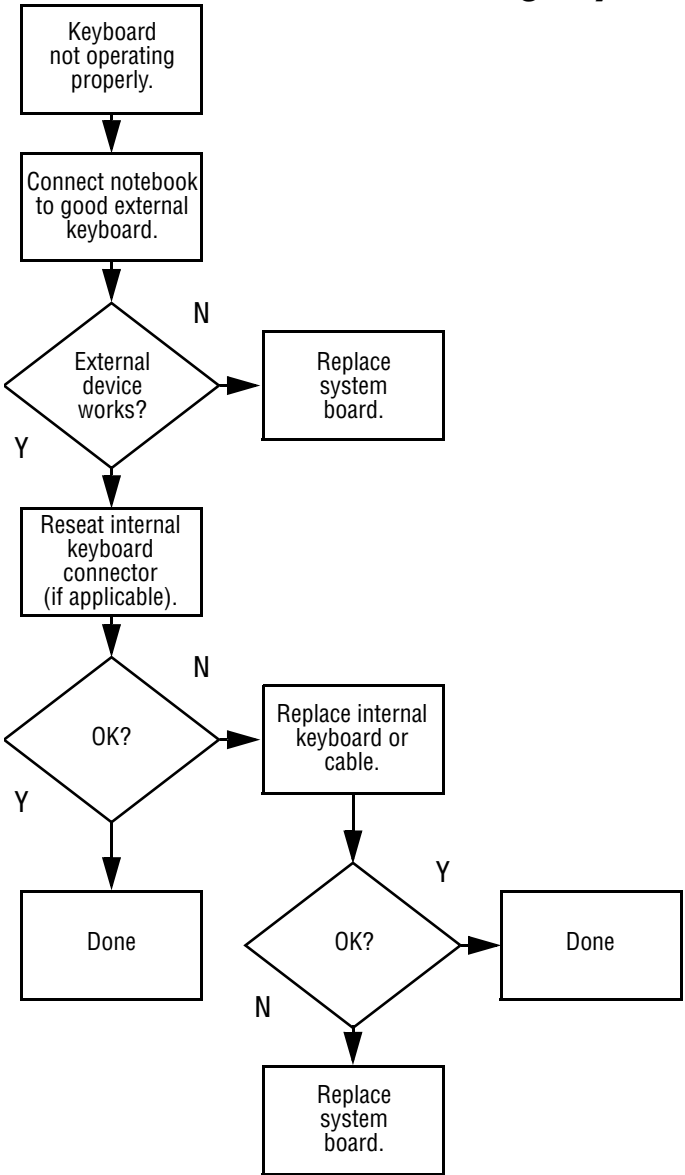

Flowchart 2.18—Nonfunctioning Pointing Device

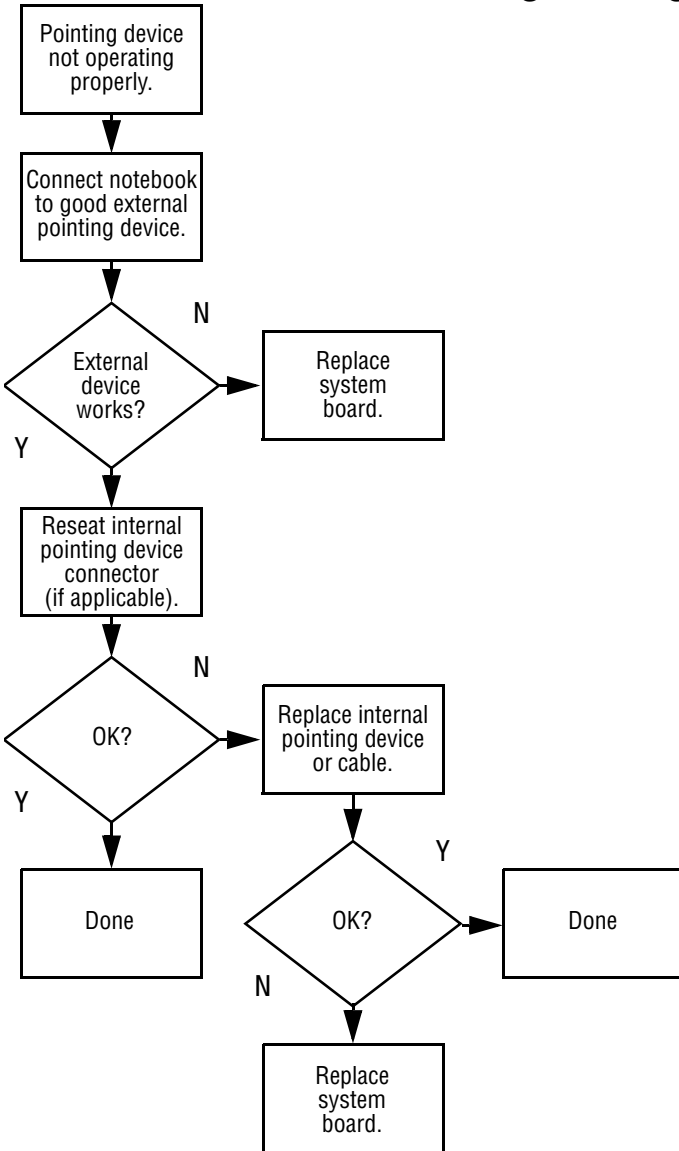

Flowchart 2.19—No Network/Modem Connection

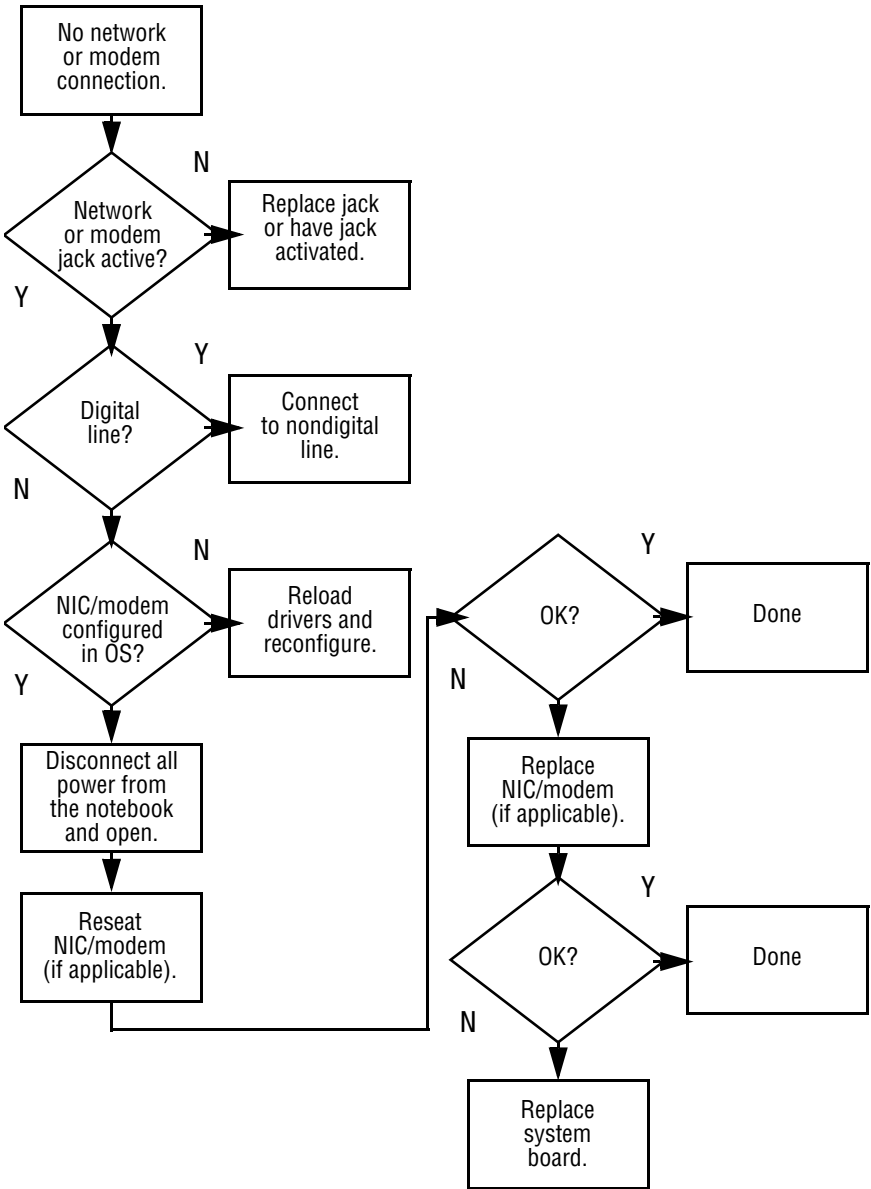

Illustrated Parts Catalog

This chapter provides an illustrated parts breakdown and a reference for spare part numbers and option part numbers.

3.1 Serial Number Location

When ordering parts or requesting information, provide the notebook serial number and model number located on the bottom of the notebook.



Serial Number Location

3.2 Notebook Major Components

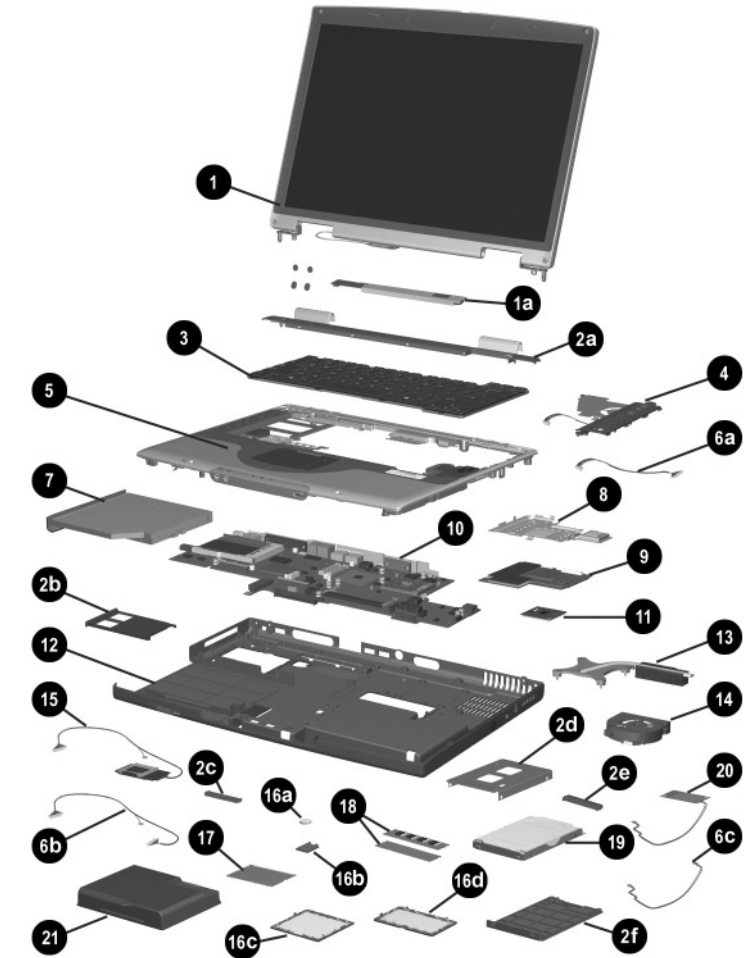

Notebook Major Components

Table 3-1
Spare Parts: Notebook Major Components

Item	Description	Spare Part Number
1	Display assemblies	
	With carbonite and platinum blue finish for use with HP Pavilion zt3000 notebooks	
	15.4-inch, WUXGA	350084-001
	15.4-inch, WSXGA+	350127-001
	15.4-inch, WXGA	350126-001
	With carbon finish for use with HP Compaq nx7000 notebooks	
	15.4-inch, WUXGA	337006-001
	15.4-inch, WSXGA+	337003-001
	15.4-inch, WXGA	337008-001
	With silver finish for use with Compaq Presario X1000 notebooks	
	15.4-inch, WUXGA	337005-001
	15.4-inch, WSXGA+	337004-001
	15.4-inch, WXGA	337007-001
1a	Display inverter (includes four display rubber screw covers)	336994-001
	Miscellaneous Plastics Kits	
	Contains parts with carbonite and platinum blue finish for use with HP Pavilion zt3000 notebooks	350130-001
	Contains parts with carbon finish for use with HP Compaq nx7000 notebooks	338133-001
	Contains parts with silver finish for use with Compaq Presario X1000 notebooks	337009-001
	Include:	
2a	Switch cover	
2b	PC Card slot space saver	
2c	Docking connector cover	
2d	Hard drive shield	
2e	Hard drive connector	
2f	Hard drive cover	
	Notebook feet (not illustrated)	

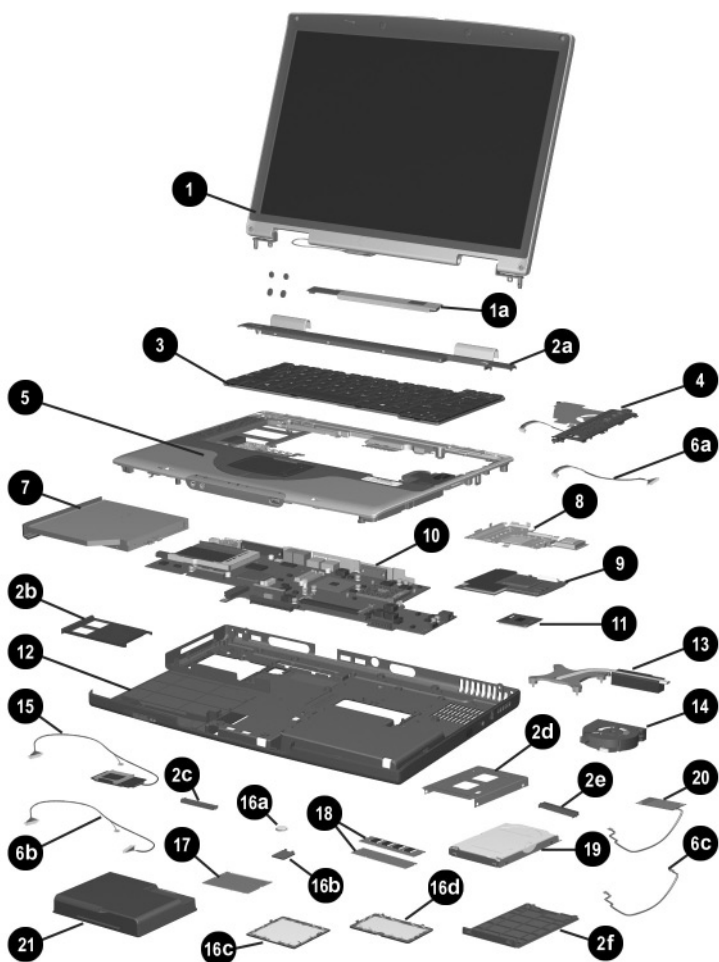

Notebook Major Components

**Table 3-1
Spare Parts: Notebook Major Components (Continued)**

Item	Description	Spare Part Number
3	Keyboards	
	Asia Pacific	337016-371
	Australia	337016-011
	Belgium	337016-181
	Denmark	337016-081
	France	337016-051
	Germany	337016-041
	Greece	337016-151
	Hong Kong	337016-AC1
	International	337016-B31
	Italy	337016-061
	Korea	337016-AD1
	Latin America	337016-161
	The Netherlands	337016-331
	Norway	337016-091
	People's Republic of China	337016-AA1
	Portugal	337016-131
	Saudi Arabia	337016-171
	Spain	337016-071
	Switzerland	337016-111
	Taiwan	337016-AB1
	Thailand	337016-281
	United Kingdom	337016-031
	United States	337016-001
4	Speaker covers with cable	
	For use with HP Pavilion zt3000 notebooks	350122-001
	For use with HP Compaq nx7000 and Compaq Presario X1000 notebooks	336973-001
5	Top covers (include TouchPad and TouchPad shield)	
	For use with HP Pavilion zt3000 notebooks	350123-001
	For use with HP Compaq nx7000 and Compaq Presario X1000 notebooks	336983-001
	Bluetooth wireless communications board (not illustrated)	338134-001
	Miscellaneous Cable Kit, includes	336973-001
6a	Speaker cover cable	
6b	SD Card slot board cable	
6c	Modem board cable	
7	Optical drives	
	24X Max DVD-ROM/CD-RW combination drive	336987-001
	8X Max DVD-ROM drive	336986-001
	24X Max CD-ROM drive	336985-001

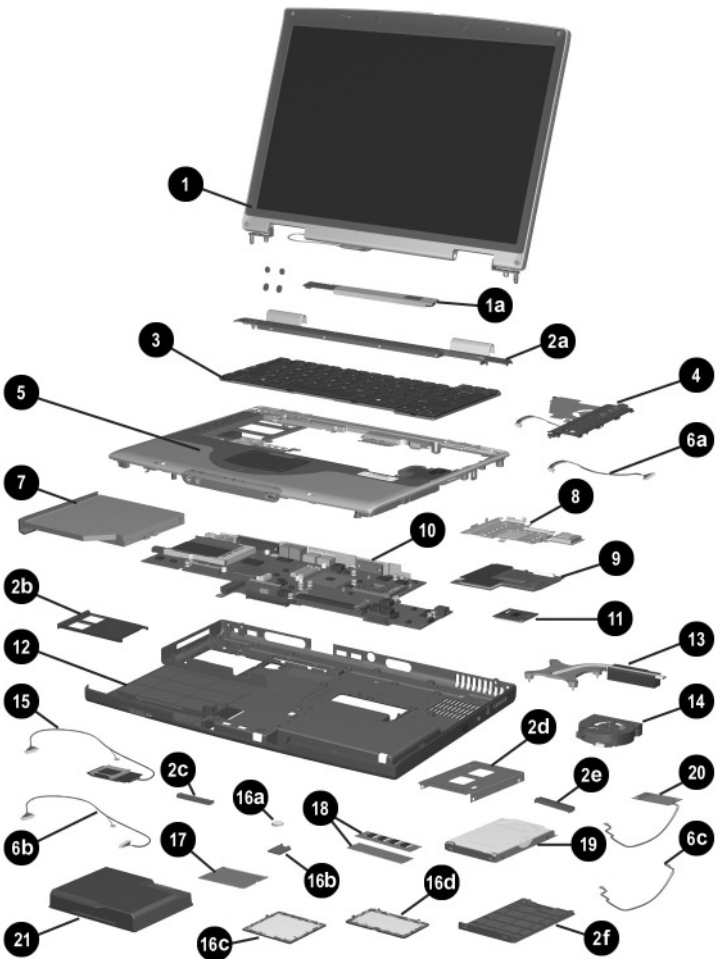

Notebook Major Components

Table 3-1
Spare Parts: Notebook Major Components (Continued)

Item	Description	Spare Part Number
8	VGA board shield (includes thermal pads)	337013-001
9	VGA boards (include thermal pads)	
	For use with HP Pavilion zt3000 notebooks	
	ATI MOBILITY RADEON 9200 with 64-MB video memory	350129-001
	ATI MOBILITY RADEON 9200 with 32-MB video memory	350128-001
	For use with HP Compaq nx7000 and Compaq Presario X1000 notebooks	
	ATI MOBILITY RADEON 9200 with 64-MB video memory	336970-001
	ATI MOBILITY RADEON 9200 with 32-MB video memory	336969-001
	ATI MOBILITY RADEON 7500c with 32-MB video memory	336968-001
10	System board (includes thermal pads)	336964-001
	PC Card assembly (not illustrated)	337014-001
11	Processors (include thermal pads)	
	Mobile Intel Pentium 4 Processor-M, 1.7-GHz	345566-001
	Mobile Intel Pentium 4 Processor-M, 1.6-GHz	337011-001
	Mobile Intel Pentium 4 Processor-M, 1.5-GHz	337023-001
	Mobile Intel Pentium 4 Processor-M, 1.4-GHz	337024-001
	Mobile Intel Pentium 4 Processor-M, 1.3-GHz	337010-001
12	Base enclosure (includes infrared lens)	336960-001
	Left and right wireless antennae with cables (not illustrated)	336959-001
	Left and right speakers (not illustrated)	337015-001
13	Heat sink with fan	337000-001
	Thermal pad (not illustrated)	337001-001
14	Fan	336993-001
15	SD Card slot board with cable	336963-001

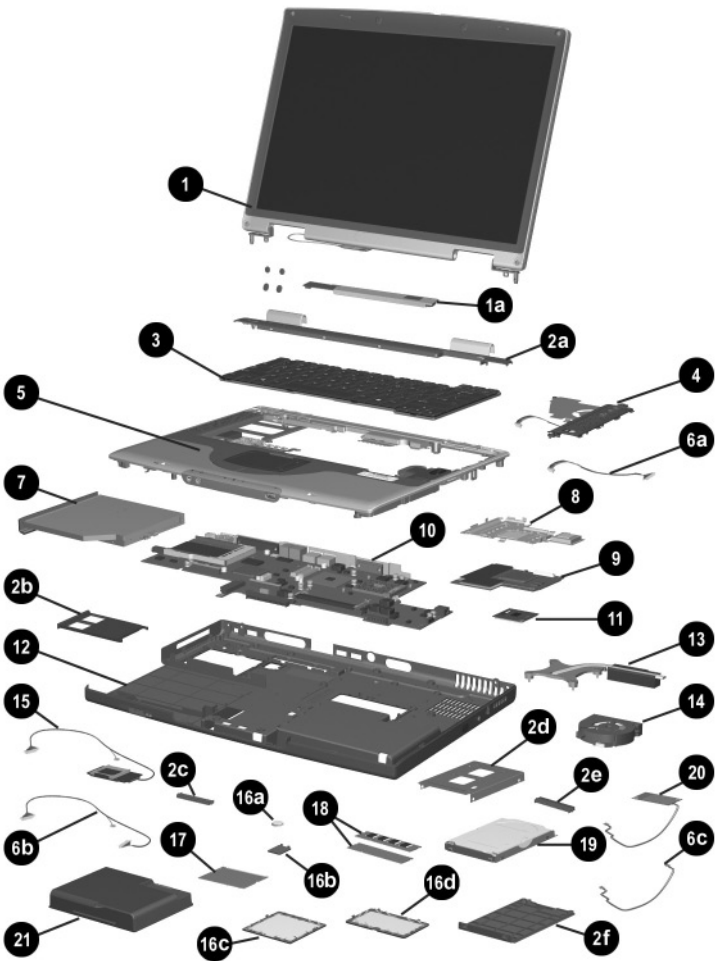

Notebook Major Components

Table 3-1
Spare Parts: Notebook Major Components (Continued)

Item	Description	Spare Part Number
	Miscellaneous Doors/Covers Kit , includes:	336984-001
16a	RTC battery	
16b	RTC battery cover	
16c	Mini PCI compartment cover	
16d	Memory expansion compartment cover	
17	Mini PCI communications boards	
	Mini PCI 802.11b wireless LAN (ROW)	336976-001
	Mini PCI 802.11b wireless LAN (MOW)	336977-001
	Mini PCI 802.11g wireless LAN	350083-001
18	Memory expansion boards	
	1024 MB DDR	339099-001
	512 MB DDR	336998-001
	256 MB DDR	336997-001
	128 MB DDR	336996-001
19	Hard drives (hard drive cover, shield, and connector included with hard drive and in Miscellaneous Plastics Kits)	
	80-GB (5400-rpm)	350082-001
	80-GB (4200-rpm)	336992-001
	60-GB (5400-rpm)	336991-001
	60-GB (4200-rpm)	336990-001
	40-GB (4200-rpm)	336989-001
	30-GB (4200-rpm)	350081-001
20	Modem board with cable	336999-001
21	Battery pack, 8-cell, 4.4-wH	336962-001

3.3 Miscellaneous Plastics Kit Components

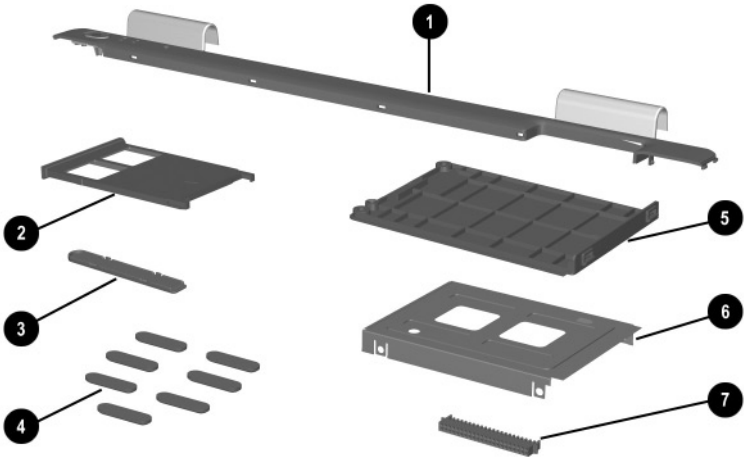

Miscellaneous Plastics Kit Components

Table 3-2

Miscellaneous Plastics Kit Components

Spare Part Number 350130-001

(contains parts with carbonite and platinum blue finish for use with HP Pavilion zt3000 notebooks)

Spare Part Number 338133-001

(contains parts with carbon finish for use with HP Compaq nx7000 notebooks)

Spare Part Number 337009-001

(contains parts with silver finish for use with Compaq Presario X1000 notebooks)

Item	Description
1	Switch cover
2	PC Card slot space saver
3	Docking connector cover
4	Notebook feet (7)
5	Hard drive cover
6	Hard drive shield
7	Hard drive connector

3.4 Miscellaneous Cable Kit Components

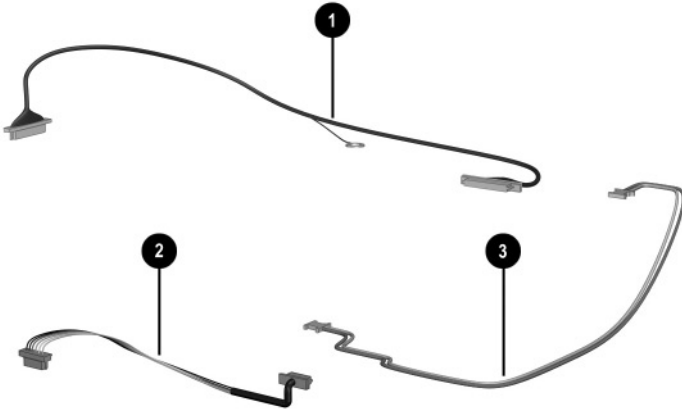

Miscellaneous Cable Kit Components

**Table 3-3
Miscellaneous Cable Kit Components
Spare Part Number 336973-001**

Item	Description
1	SD Card slot board cable
2	Speaker cover cable
3	Modem cable

3.5 Miscellaneous Doors/Covers Kit Components

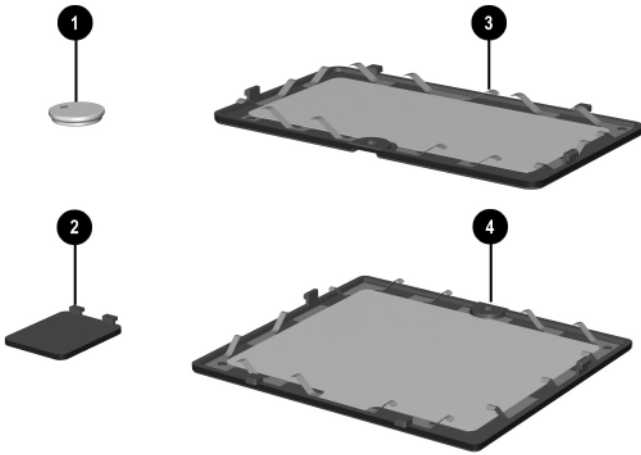

Miscellaneous Doors/Covers Kit Components

**Table 3-4
Miscellaneous Doors/Covers Kit Components
Spare Part Number 336984-001**

Item	Description
1	RTC battery
2	RTC battery cover
3	Memory expansion compartment cover
4	Mini PCI compartment cover

3.6 Mass Storage Devices

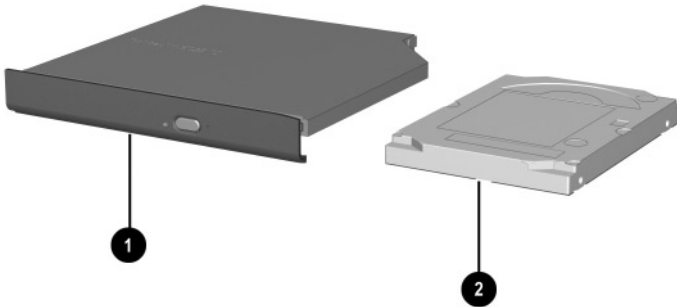

Mass Storage Devices

**Table 3-5
Mass Storage Devices
Spare Part Number Information**

Item	Description	Spare Part Number
1	Optical drives	
	24X Max DVD-ROM/CD-RW combination drive	336987-001
	8X Max DVD-ROM drive	336986-001
	24X Max CD-ROM drive	336985-001
	DVD+RW drive	345588-001
2	Hard drives (include hard drive bezel and frame)	
	80-GB (5400-rpm)	350082-001
	80-GB (4200-rpm)	336992-001
	60-GB (5400-rpm)	336991-001
	60-GB (4200-rpm)	336990-001
	40-GB (4200-rpm)	336989-001
	30-GB (4200-rpm)	350081-001
	USB diskette drive (not illustrated)	336988-001

3.7 Miscellaneous

Table 3-6
Miscellaneous (not illustrated)
Spare Part Information

Description	Spare Part Number
AC adapter	338136-001
Logo Kits	
For use with HP Pavilion zt3000 notebooks	350125-001
For use with HP Compaq nx7000 notebooks	336995-001
For use with Compaq Presario X1000 notebooks	338135-001
Power cords	
For use with HP Pavilion zt3000 notebooks	
Asia Pacific	350055-371
Australia	350055-011
Belgium	350055-181
Denmark	350055-081
Europe	350055-021
France	350055-051
Germany	350055-041
Greece	350055-151
Hong Kong	350055-AC1
Italy	350055-061
Korea	350055-AD1
Latin America	350055-161
The Netherlands	350055-331
Norway	350055-091
People's Republic of China	350055-AA1
Portugal	350055-131
Saudi Arabia	350055-171
Spain	350055-071
Switzerland	350055-111
Taiwan	350055-AB1
Thailand	350055-281
United Kingdom	350055-031
United States	350055-001

Table 3-6
Miscellaneous (not illustrated)
Spare Part Information (*Continued*)

Description			Spare Part Number
Power cords			
For use with HP Compaq nx7000 and Compaq Presario X1000 notebooks			
Australia	246959-011	Japan	246959-291
Denmark	246959-081	Korea	246959-AD1
Europe/Middle		Switzerland	246959-AG1
East/Africa	246959-021	United Kingdom	246959-031
Italy	246959-061	United States	246959-001
Screw Kit (includes the following screws; refer to Appendix C, "Screw Listing," for more information on screw specifications and usage.)			337012-001
■ Phillips M2.5×15.0 screw		■ Phillips M2.5×3.5 screw	
■ Phillips M2.5×7.0 screw		■ Phillips M2.5×3.0 screw	
■ Phillips M2.5×5.0 screw		■ Phillips M2.0×3.0 screw	
■ Spring-loaded Phillips M2.0×9.0 screw			

Removal and Replacement Preliminaries

This chapter provides essential information for proper and safe removal and replacement service.

4.1 Tools Required

You will need the following tools to complete the removal and replacement procedures:

- Magnetic screwdriver
- Phillips P0 screwdriver
- 5.0-mm socket for system board standoffs
- Flat-bladed screwdriver
- Tool kit (includes connector removal tool, loopback plugs, and case utility tool)

4.2 Service Considerations

The following sections include some of the considerations that you should keep in mind during disassembly and assembly procedures.



As you remove each subassembly from the notebook, place the subassembly (and all accompanying screws) away from the work area to prevent damage.

Plastic Parts

Using excessive force during disassembly and reassembly can damage plastic parts. Use care when handling the plastic parts. Apply pressure only at the points designated in the maintenance instructions.

Cables and Connectors



CAUTION: When servicing the notebook, ensure that cables are placed in their proper locations during the reassembly process. Improper cable placement can damage the notebook.

Cables must be handled with extreme care to avoid damage. Apply only the tension required to unseat or seat the cables during removal and insertion. Handle cables by the connector whenever possible. In all cases, avoid bending, twisting, or tearing cables. Ensure that cables are routed in such a way that they cannot be caught or snagged by parts being removed or replaced. Handle flex cables with extreme care; these cables tear easily.

4.3 Preventing Damage to Removable Drives

Removable drives are fragile components that must be handled with care. To prevent damage to the notebook, damage to a removable drive, or loss of information, observe the following precautions:

- Before removing or inserting a hard drive, shut down the notebook. If you are unsure whether the notebook is off or in Hibernation, turn the notebook on, then shut it down.
- Before removing a diskette drive or optical drive, ensure that a diskette or disc is not in the drive. Ensure that the optical drive tray is closed.
- Before handling a drive, ensure that you are discharged of static electricity. While handling a drive, avoid touching the connector.
- Handle drives on surfaces that have at least one inch of shock-proof foam.
- Avoid dropping drives from any height onto any surface.
- After removing a hard drive, CD-ROM drive, or a diskette drive, place it in a static-proof bag.
- Avoid exposing a hard drive to products that have magnetic fields, such as monitors or speakers.
- Avoid exposing a drive to temperature extremes or liquids.
- If a drive must be mailed, place the drive in a bubble pack mailer or other suitable form of protective packaging and label the package, "Fragile: Handle With Care."

4.4 Preventing Electrostatic Damage

Many electronic components are sensitive to electrostatic discharge (ESD). Circuitry design and structure determine the degree of sensitivity. Networks built into many integrated circuits provide some protection, but in many cases, the discharge contains enough power to alter device parameters or melt silicon junctions.

A sudden discharge of static electricity from a finger or other conductor can destroy static-sensitive devices or microcircuitry. Often the spark is neither felt nor heard, but damage occurs.

An electronic device exposed to electrostatic discharge might not be affected at all and can work perfectly throughout a normal cycle. Or the device might function normally for a while, then degrade in the internal layers, reducing its life expectancy.

4.5 Packaging and Transporting Precautions

Use the following grounding precautions when packaging and transporting equipment:

- To avoid hand contact, transport products in static-safe containers, such as tubes, bags, or boxes.
- Protect all electrostatic-sensitive parts and assemblies with conductive or approved containers or packaging.
- Keep electrostatic-sensitive parts in their containers until the parts arrive at static-free workstations.
- Place items on a grounded surface before removing items from their containers.
- Always be properly grounded when touching a sensitive component or assembly.

- Store reusable electrostatic-sensitive parts from assemblies in protective packaging or nonconductive foam.
- Use transporters and conveyors made of antistatic belts and roller bushings. Ensure that mechanized equipment used for moving materials is wired to ground and that proper materials are selected to avoid static charging. When grounding is not possible, use an ionizer to dissipate electric charges.

4.6 Workstation Precautions

Use the following grounding precautions at workstations:

- Cover the workstation with approved static-shielding material (refer to Table 4-2).
- Use a wrist strap connected to a properly grounded work surface and use properly grounded tools and equipment.
- Use conductive field service tools, such as cutters, screwdrivers, and vacuums.
- When using fixtures that must directly contact dissipative surfaces, only use fixtures made of static-safe materials.
- Keep the work area free of nonconductive materials, such as ordinary plastic assembly aids and Styrofoam.
- Handle electrostatic-sensitive components, parts, and assemblies by the case or PCM laminate. Handle these items only at static-free workstations.
- Avoid contact with pins, leads, or circuitry.
- Turn off power and input signals before inserting or removing connectors or test equipment.

4.7 Grounding Equipment and Methods

Grounding equipment must include either a wrist strap or a foot strap at a grounded workstation.

- When seated, wear a wrist strap connected to a grounded system. Wrist straps are flexible straps with a minimum of one megohm $\pm 10\%$ resistance in the ground cords. To provide proper ground, wear a strap snugly against the skin at all times. On grounded mats with banana-plug connectors, use alligator clips to connect a wrist strap.
- When standing, use foot straps and a grounded floor mat. Foot straps (heel, toe, or boot straps) can be used at standing workstations and are compatible with most types of shoes or boots. On conductive floors or dissipative floor mats, use foot straps on both feet with a minimum of one megohm resistance between the operator and ground. To be effective, the conductive strips must be worn in contact with the skin.

Other grounding equipment recommended for use in preventing electrostatic damage includes:

- Antistatic tape
- Antistatic smocks, aprons, and sleeve protectors
- Conductive bins and other assembly or soldering aids
- Nonconductive foam
- Conductive tabletop workstations with ground cords of one megohm resistance
- Static-dissipative tables or floor mats with hard ties to the ground
- Field service kits
- Static awareness labels
- Material-handling packages
- Nonconductive plastic bags, tubes, or boxes

- Metal tote boxes
- Electrostatic voltage levels and protective materials

Table 4-1 shows how humidity affects the electrostatic voltage levels generated by different activities.

**Table 4-1
Typical Electrostatic Voltage Levels**

Event	Relative Humidity		
	10%	40%	55%
Walking across carpet	35,000 V	15,000 V	7,500 V
Walking across vinyl floor	12,000 V	5,000 V	3,000 V
Motions of bench worker	6,000 V	800 V	400 V
Removing DIPS from plastic tube	2,000 V	700 V	400 V
Removing DIPS from vinyl tray	11,500 V	4,000 V	2,000 V
Removing DIPS from Styrofoam	14,500 V	5,000 V	3,500 V
Removing bubble pack from PCB	26,500 V	20,000 V	7,000 V
Packing PCBs in foam-lined box	21,000 V	11,000 V	5,000 V



A product can be degraded by as little as 700 V.

Table 4-2 lists the shielding protection provided by antistatic bags and floor mats.

**Table 4-2
Static-Shielding Materials**

Material	Use	Voltage Protection Level
Antistatic plastic	Bags	1,500 V
Carbon-loaded plastic	Floor mats	7,500 V
Metallized laminate	Floor mats	5,000 V

5

Removal and Replacement Procedures

This chapter provides removal and replacement procedures.

There are 50 Phillips screws, in nine different sizes, that must be removed, replaced, and/or loosened when servicing the notebook. Make special note of each screw size and location during removal and replacement.

Refer to Appendix C, “Screw Listing,” for detailed information on screw sizes, locations, and usage.

5.1 Serial Number

Report the notebook serial number to HP when requesting information or ordering spare parts. The serial number is located on the bottom of the notebook.



Serial Number Location

5.2 Disassembly Sequence Chart

Use the following chart to determine the section number to be referenced when removing notebook components.

Disassembly Sequence Chart

Section	Description	# of Screws Removed
5.3	Preparing the notebook for disassembly	
	Battery pack	0
	Hard drive	2
	Hard drive cover and shield	4
5.4	Notebook feet	0
5.5	Memory expansion board	1
5.6	Mini PCI communications board	1
5.7	RTC battery	0
5.8	Optical drive	1
5.9	Keyboard	2
5.10	Switch cover	0
5.11	Speaker cover	4
5.12	Fan	1
5.13	Heat sink	4
5.14	Processor	0
5.15	Display assembly	7
5.16	Top cover	16
5.17	Bluetooth board	2
5.18	SD Card slot board and cable	2
5.19	VGA board and shield	2
5.20	Modem board and cable	0
5.21	System board	1

5.3 Preparing the Notebook for Disassembly

Before you begin any removal or installation procedures:

1. Save your work, exit all applications, and shut down the notebook. If you are not sure whether the notebook is off or in Hibernation, briefly press the power button. If your work returns to the screen, save your work, exit all applications, and then shut down the notebook.
2. Disconnect all external devices connected to the notebook.
3. Disconnect the power cord.
4. Remove the battery pack by following these steps:

Spare Part Number Information

Battery pack, 8-cell, 4.4-wH

336962-001

- a. Turn the notebook upside down, with the rear panel facing you.

- b. Slide and hold ❶ the battery release latch to the right. The front edge of the battery pack releases from the notebook.
- c. Lift the front edge of the battery pack up and swing it back ❷.

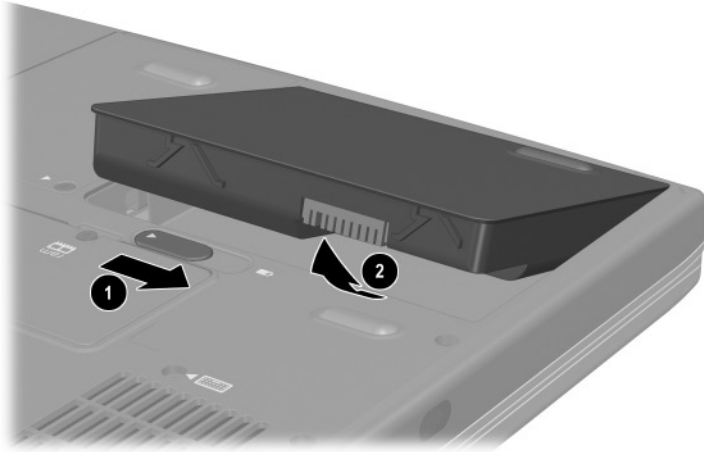

Removing the Battery Pack

- d. Remove the battery pack.

Reverse the above procedure to install the battery pack.

Spare Part Number Information

Hard drives (hard drive cover, shield, and connector included with hard drive and in Miscellaneous Plastics Kits)

80-GB (5400-rpm)	350082-001
80-GB (4200-rpm)	336992-001
60-GB (5400-rpm)	336991-001
60-GB (4200-rpm)	336990-001
40-GB (4200-rpm)	336989-001
30-GB (4200-rpm)	350081-001

5. Remove the hard drive by following these steps:
 - a. Turn the notebook upside down, with the front facing you.
 - b. Remove the two PM2.5×9.5 screws ❶ that secure the hard drive to the notebook.
 - c. Use the notch ❷ on the hard drive cover to lift the rear edge of the hard drive up and swing it forward ❸.

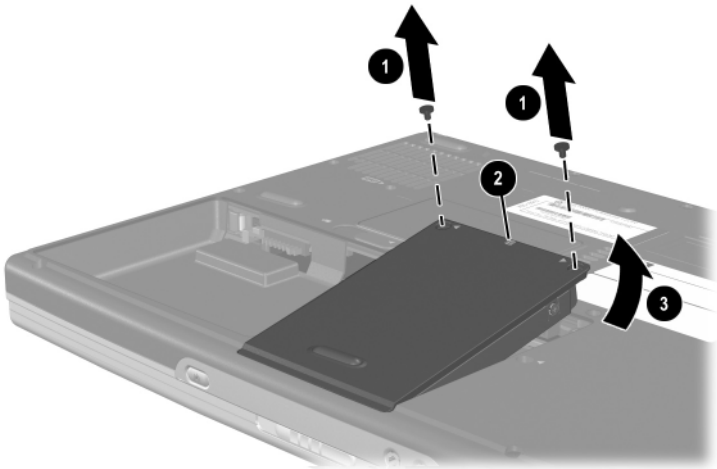

Removing the Hard Drive

- d. Remove the hard drive.



CAUTION: The hard drive cover should be removed only if it is damaged and must be replaced. Unnecessarily removing the cover can result in damage to the cover and hard drive and loss of information.

- e. Remove the four PM2.5×3.5 screws ❶ that secure the hard drive to the hard drive cover and shield.
- f. Remove the hard drive shield ❷ and connector ❸ from the hard drive.
- g. Separate the hard drive from the hard drive cover ❹.

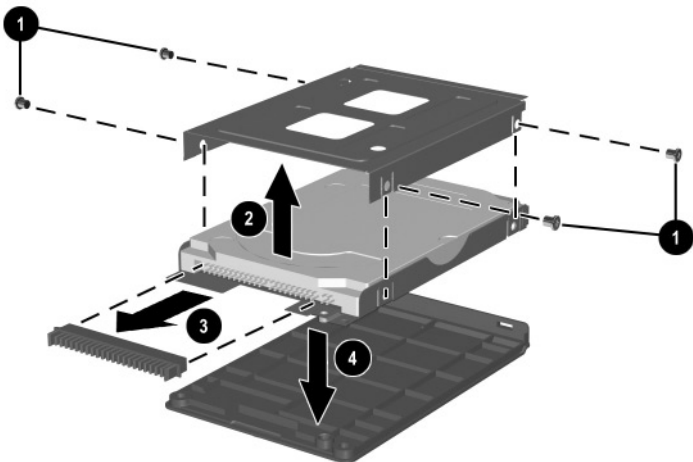

Removing the Hard Drive from the Hard Drive Cover



The hard drive cover, shield, and connector are included with the hard drive and also in the Miscellaneous Plastics Kits, spare part number 350130-001 for HP Pavilion zt3000 models, spare part number 338133-001 for HP Compaq nx7000 models, and spare part number 337009-001 for Compaq Presario X1000 models.

Reverse the above procedure to install the hard drive.

5.4 Notebook Feet

The notebook feet are adhesive-backed rubber pads, and are included in the Miscellaneous Plastics Kits, spare part number 350130-001 for HP Pavilion zt3000 models, spare part number 338133-001 for HP Compaq nx7000 models, and spare part number 337009-001 for Compaq Presario X1000 models. The notebook feet attach to the base enclosure as indicated in the following illustration.

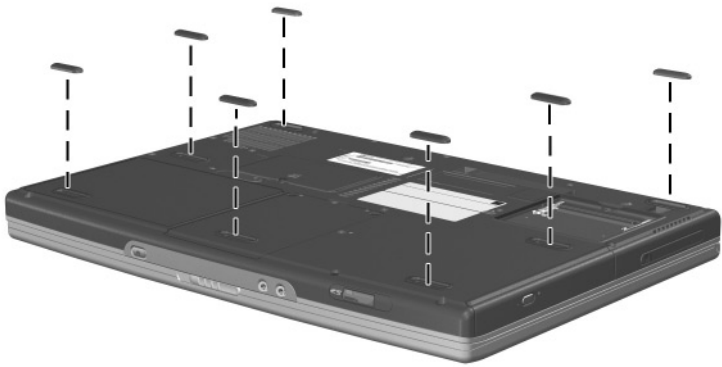

Replacing the Notebook Feet

5.5 Memory Expansion Board

Spare Part Number Information

1024-MB DDR memory expansion board	336909-001
512-MB DDR memory expansion board	336998-001
256-MB DDR memory expansion board	336997-001
128-MB DDR memory expansion board	336996-001

1. Prepare the notebook for disassembly (Section 5.3).
2. Turn the notebook upside down, with the front facing you.
3. Loosen the PM2.5×5.0 screw ❶ that secures the memory expansion compartment cover to the notebook.
4. Lift the front edge of the cover up ❷ and swing it back.

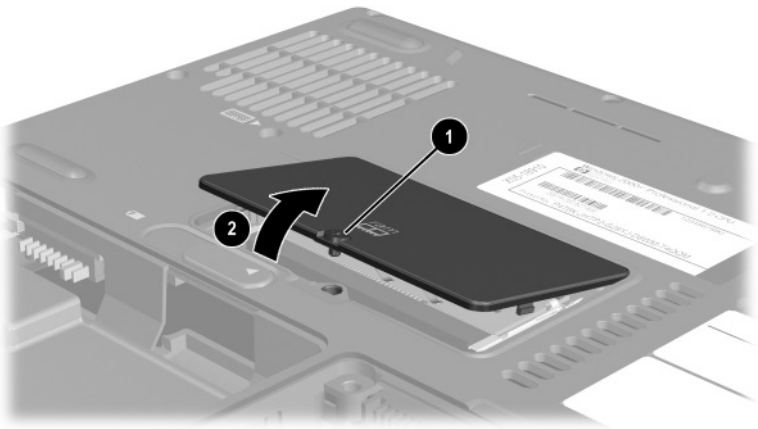

Removing the Memory Expansion Compartment Cover

5. Remove the cover.



The memory expansion compartment cover is included in the Miscellaneous Doors/Covers Kit, spare part number 336984-001.

6. Spread the retaining tabs ❶ that secure the memory expansion board to the socket. The board rises up at a 45-degree angle.
7. Pull the board away from the socket at a 45-degree angle ❷.

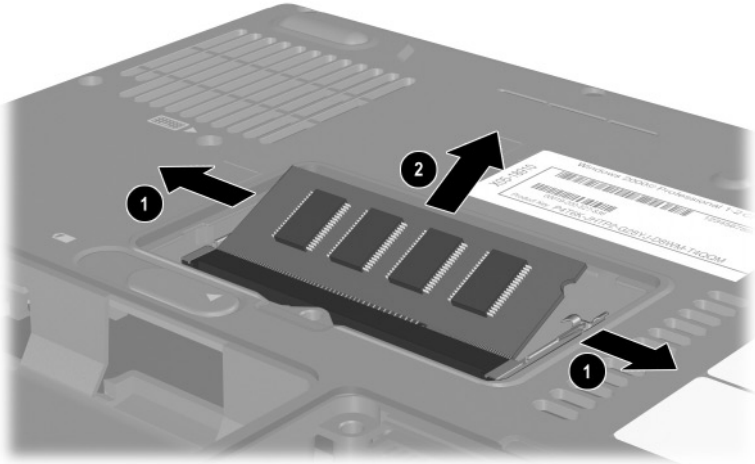

Removing the Memory Expansion Board

Reverse the above procedure to install a memory expansion board.

5.6 Mini PCI Communications Board

Spare Part Number Information

Mini PCI 802.11b wireless LAN (ROW)	336976-001
Mini PCI 802.11b wireless LAN (MOW)	336977-001
Mini PCI 802.11g wireless LAN	350083-001

1. Prepare the notebook for disassembly (Section 5.3).
2. Turn the notebook upside down, with the front facing you.
3. Loosen the PM2.5×5.0 screw **1** that secures the Mini PCI compartment cover to the notebook.
4. Lift the rear edge of the cover up **2** and swing it forward.

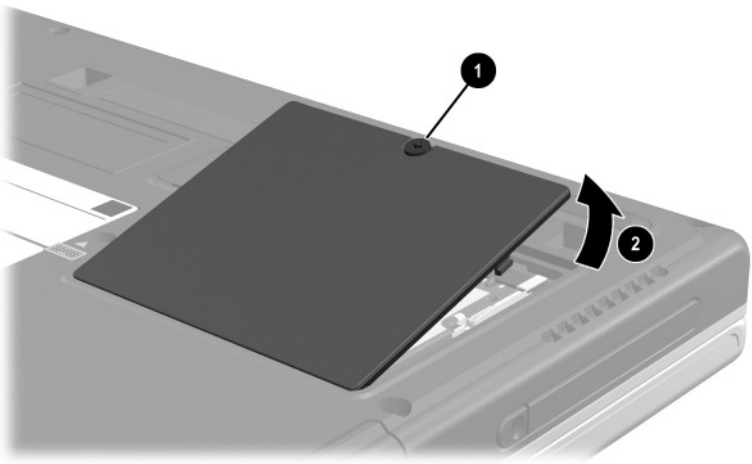

Removing the Mini PCI Compartment Cover

5. Remove the cover.



The Mini PCI compartment cover is included in the Miscellaneous Doors/Covers Kit, spare part number 336984-001.

6. Disconnect the two antenna cables from the terminals on the Mini PCI communications board ❶. Note that the longer of the two cables should be connected to the left antenna terminal (marked “AUX”) and the shorter cable should be connected to the right terminal (marked “MAIN”).
7. Spread the retaining tabs ❷ that secure the memory expansion board to the socket. The board rises up at a 45-degree angle.
8. Pull the board away from the socket at a 45-degree angle ❸.

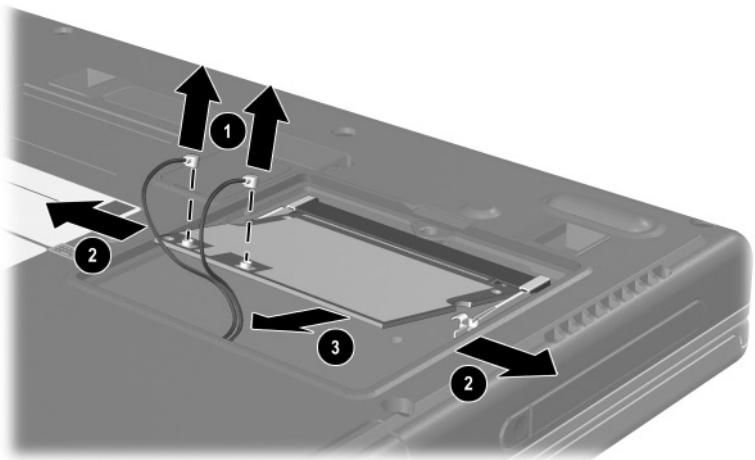

Removing the Mini PCI Communications Board

Reverse the above procedure to install a Mini PCI communications board.

5.7 RTC Battery



The RTC battery and RTC battery cover are included in the Miscellaneous Doors/Covers Kit, spare part number 336984-001.

1. Prepare the notebook for disassembly (Section 5.3).
2. Turn the notebook upside down, with the front facing you.
3. Insert a flat-bladed tool into the notch **1** on the front edge of the RTC battery cover and separate the front edge of the cover from the notebook.
4. Remove the RTC battery from the socket on the system board **2**.

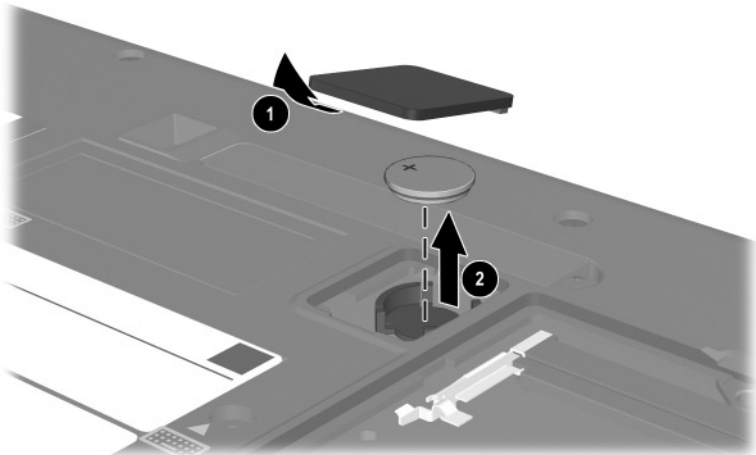

Removing the RTC battery

Reverse the above procedure to install an RTC battery.

5.8 Optical Drive

Spare Part Number Information

24X Max DVD-ROM/CD-RW combination drive	336987-001
8X Max DVD-ROM drive	336986-001
24X Max CD-ROM drive	336985-001

1. Prepare the notebook for disassembly (Section 5.3).
2. Turn the notebook upside down, with the front facing you.
3. Remove the PM2.5×9.5 screw ❶ that secures the optical drive to the notebook.
4. Insert a slender tool into the slot in the hard drive bay and push to the right to disengage the optical drive from the notebook ❷.

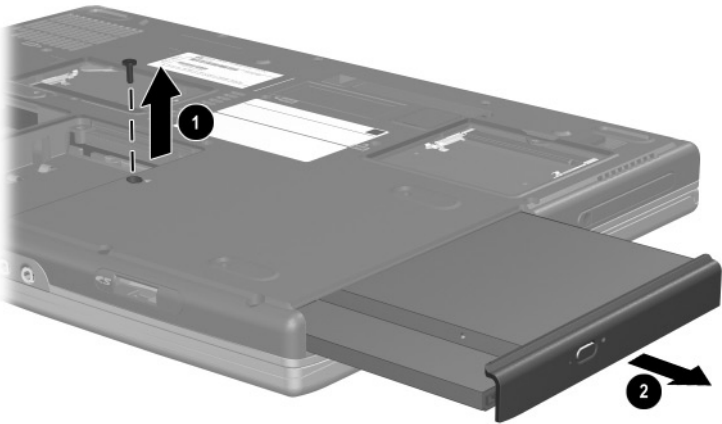

Removing the Optical Drive

5. Remove the optical drive.

Reverse the above procedure to install an optical drive.

5.9 Keyboard

Spare Part Number Information

Asia Pacific	337016-371	The Netherlands	337016-331
Australia	337016-011	Norway	337016-091
Belgium	337016-181	People's Republic of China	337016-AA1
Denmark	337016-081	Portugal	337016-131
France	337016-051	Saudi Arabia	337016-171
Germany	337016-041	Spain	337016-071
Greece	337016-151	Switzerland	337016-111
Hong Kong	337016-AC1	Taiwan	337016-AB1
International	337016-B31	Thailand	337016-281
Italy	337016-061	United Kingdom	337016-031
Korea	337016-AD1	United States	337016-001
Latin America	337016-161		

1. Prepare the notebook for disassembly (Section 5.3).
2. Turn the notebook upside down, with the front facing you.
3. Remove the two PM2.5×15.0 screws that secure the keyboard to the base enclosure.

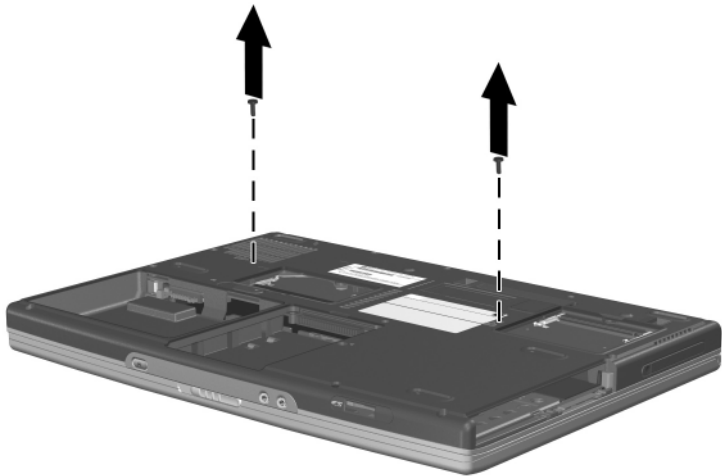

Removing the Keyboard Screws

4. Turn the notebook right-side up with the front facing you.
5. Open the notebook.
6. Slide the four notches on the top edge of the keyboard toward you.

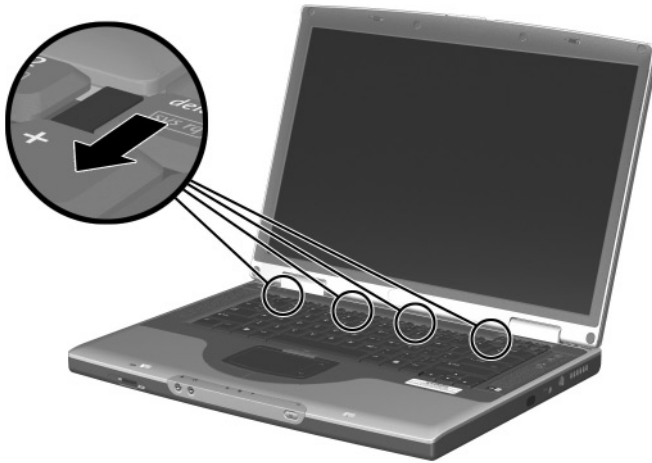

Releasing the Keyboard

7. Lift the rear edge of the keyboard, swing it up and forward **1**, and rest it on the top cover.
8. Release the ZIF connector **2** to which the keyboard cable is attached and disconnect the keyboard cable **3** from the system board.

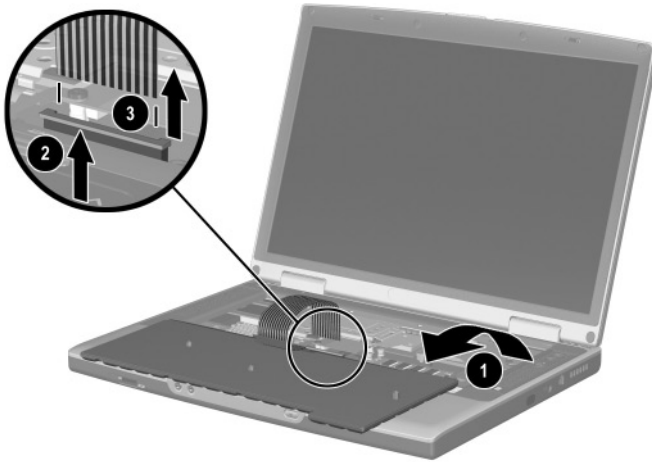

Disconnecting the Keyboard Cable

9. Remove the keyboard.

Reverse the above procedure to install the keyboard.

After the keyboard is removed, the internal memory expansion board connector is accessible. Refer to the “Memory Expansion Board” section for instructions on removing the internal memory expansion board.

5.10 Switch Cover



The switch cover is included in the Miscellaneous Plastics Kits, spare part number 350130-001 for HP Pavilion zt3000 models, spare part number 338133-001 for HP Compaq nx7000 models, and spare part number 337009-001 for Compaq Presario X1000 models.

1. Prepare the notebook for disassembly (Section 5.3).
2. Remove the keyboard (Section 5.9).
3. Insert a flat-bladed tool under the outside edges of the hinge cover areas and lift up to disengage the left and right sides of the cover from the notebook.
4. Remove the switch cover.

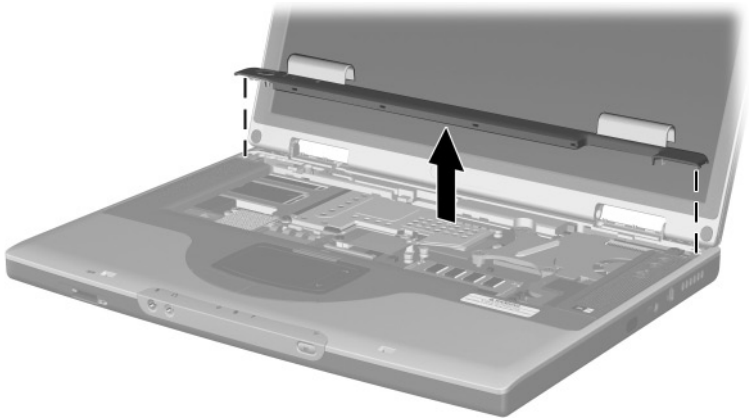

Removing the Switch Cover

Reverse the above procedure to install the switch cover.

5.11 Speaker Cover

Spare Part Number Information

Speaker cover with cable

For use with HP Pavilion zt3000 notebooks

350122-001

For use with HP Compaq nx7000 and

336973-001

Compaq Presario X1000 notebooks

The speaker cover cable is also included in the Miscellaneous Cable Kit, spare part number 336973-001.

1. Prepare the notebook for disassembly (Section 5.3).
2. Remove the keyboard (Section 5.9).
3. Remove the switch cover (Section 5.10).
4. Disconnect the audio cable ❶ from the system board.
5. Remove the three PM2.5×5.0 screws ❷ and the PM2.5×3.0 screw ❸ that secure the speaker cover to the notebook.

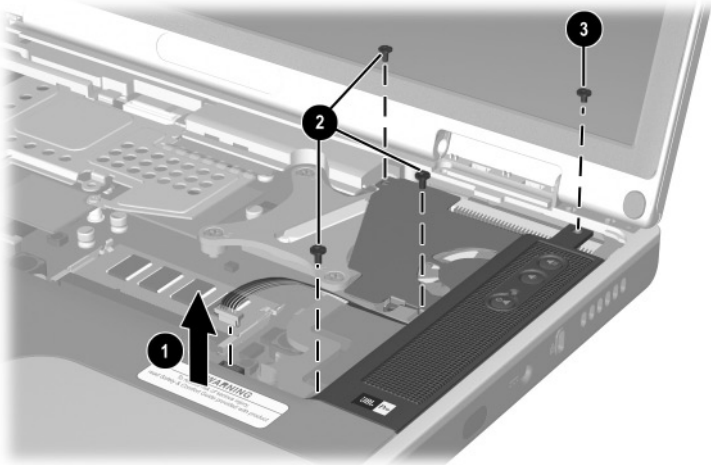

Removing the Speaker Cover Screws

6. Lift the left side of the speaker cover shield and swing it up and slightly to the right ❶.
7. Slide the speaker cover back ❷ to disengage it from the notebook.
8. Remove the speaker cover.

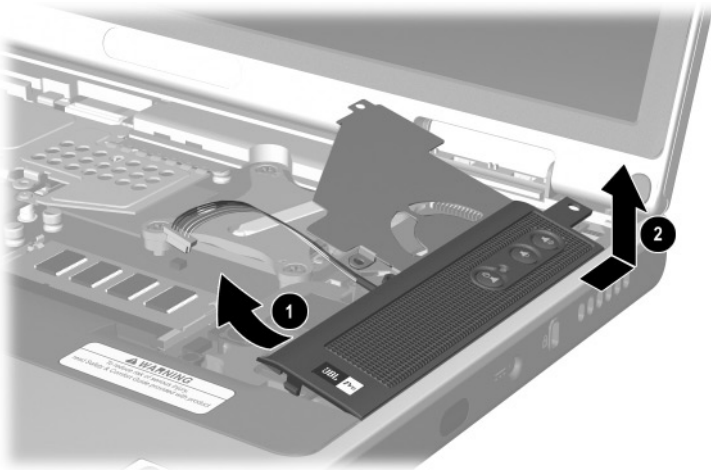

Removing the Speaker Cover

Reverse the above procedure to install the speaker cover.

5.12 Fan

Spare Part Number Information

Fan

336993-001

The fan is also included with the heat sink, spare part number 337000-001.

1. Prepare the notebook for disassembly (Section 5.3).
2. Remove the keyboard (Section 5.9).
3. Remove the switch cover (Section 5.10).
4. Remove the speaker cover (Section 5.11).
5. Disconnect the fan cable ❶ from the system board.
6. Remove the PM2.5×5.0 screw ❷ that secures the fan to the base enclosure.
7. Remove the fan ❸.

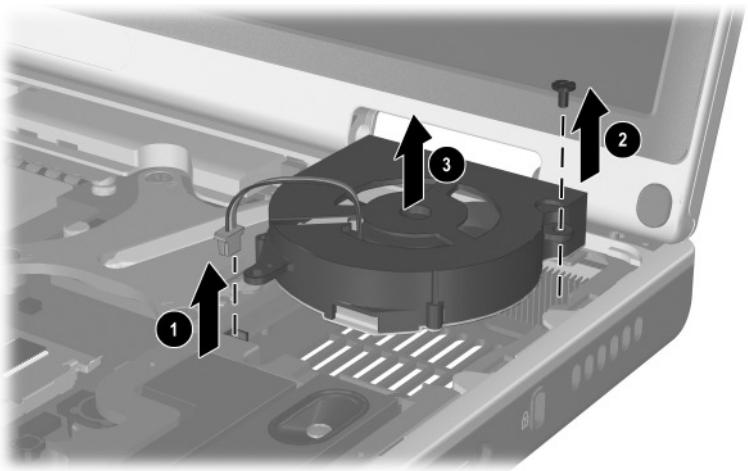

Removing the Fan

Reverse the above procedure to install the fan.

5.13 Heat Sink

Spare Part Number Information

Heat sink with fan	337000-001
Thermal pad	337001-001

1. Prepare the notebook for disassembly (Section 5.3) and remove the following components:
 - ❑ Keyboard (Section 5.9)
 - ❑ Switch cover (Section 5.10)
 - ❑ Speaker cover (Section 5.11)
 - ❑ Fan (Section 5.12)
2. Remove the four PM2.0×9.0 spring-loaded shoulder screws ❶ that secure the heat sink to the notebook.
3. Lift the front edge of the heat sink ❷ and slide the heat sink out of the notebook at an angle ❸.

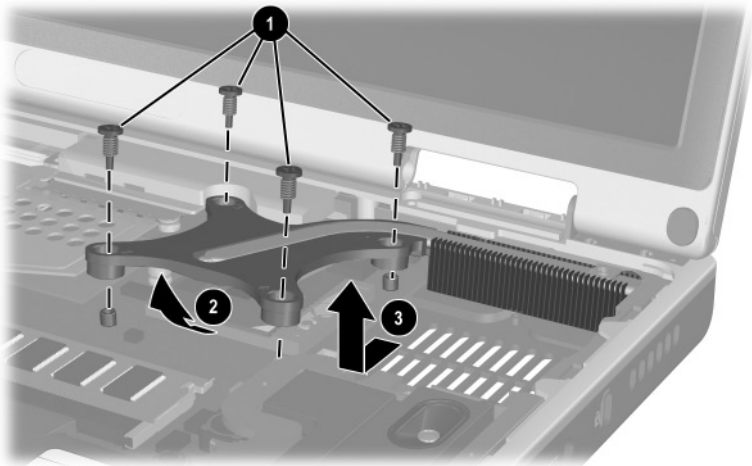

Removing the Heat Sink



Carefully clean any thermal grease residue from the heat sink **1** and processor surfaces **2** each time you remove the heat sink. Apply new thermal grease to both surfaces.

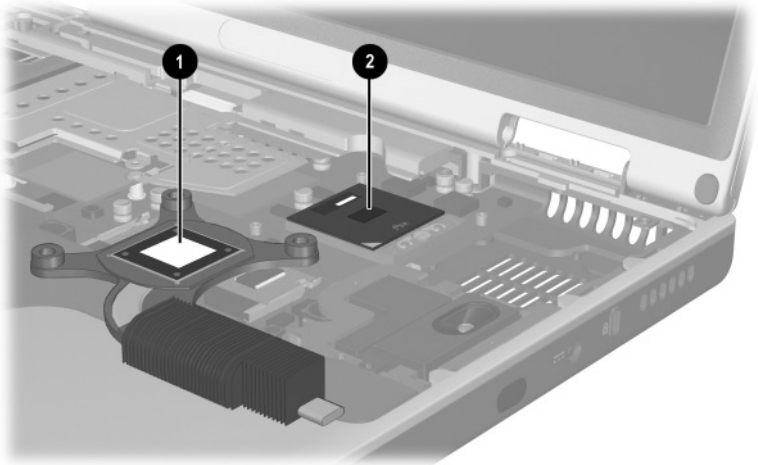

Removing the Thermal Grease From the Heat Sink and Processor
Reverse the above procedure to install the heat sink.

5.14 Processor

Spare Part Number Information

Mobile Intel Pentium 4 Processor-M, 1.7-GHz	345566-001
Mobile Intel Pentium 4 Processor-M, 1.6-GHz	337011-001
Mobile Intel Pentium 4 Processor-M, 1.5-GHz	337023-001
Mobile Intel Pentium 4 Processor-M, 1.4-GHz	337024-001
Mobile Intel Pentium 4 Processor-M, 1.3-GHz	337010-001

1. Prepare the notebook for disassembly (Section 5.3) and remove the following components:
 - Keyboard (Section 5.9)
 - Switch cover (Section 5.10)
 - Speaker cover (Section 5.11)
 - Fan (Section 5.12)
 - Heat sink (Section 5.13)

2. Use a flat-bladed tool to turn the processor locking screw ❶ one-quarter turn counterclockwise.
3. Lift the processor straight up ❷ and remove it.



Note that the gold triangle ❸ should be in the lower right corner when installing the processor.

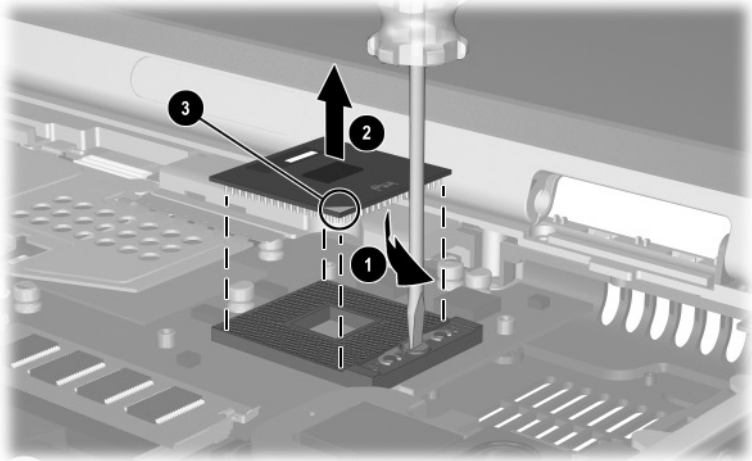

Removing the Processor

Reverse the above procedure to install the processor.

5.15 Display Assembly

Spare Part Number Information

With carbonite and platinum blue finish for use with	
HP Pavilion zt3000 notebooks	
15.4-inch, WUXGA	350084-001
15.4-inch, WSXGA+	350127-001
15.4-inch, WXGA	350126-001
With carbon finish for use with HP Compaq nx7000 notebooks	
15.4-inch, WUXGA	337006-001
15.4-inch, WSXGA+	337003-001
15.4-inch, WXGA	337008-001
With silver finish for use with Compaq Presario X1000 notebooks	
15.4-inch, WUXGA	337005-001
15.4-inch, WSXGA+	337004-001
15.4-inch, WXGA	337007-001
Display inverter (includes four display rubber screw covers)	336994-001

1. Prepare the notebook for disassembly (Section 5.3).
2. Remove the keyboard (Section 5.9).
3. Remove the switch cover (Section 5.10).

4. Remove the PM2.5×15.0 screw ❶ that secures the display cable to the base enclosure.
5. Disconnect the display video cable ❷ from the system board.

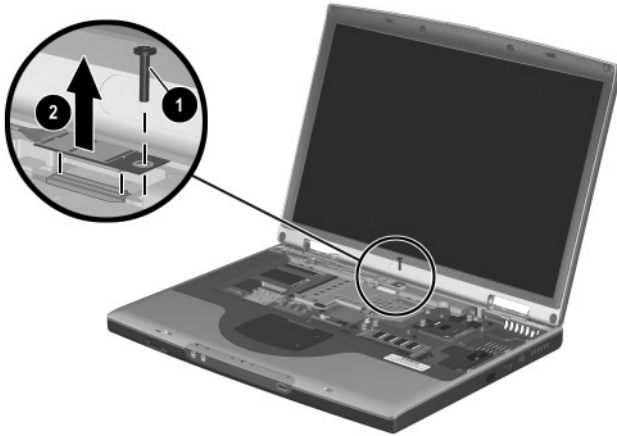

Disconnecting the Display Cable

6. Close the notebook and turn the notebook upside down, with the rear panel facing you.
7. Remove the following screws:
 - ❑ Two PM2.5×9.5 screws **1** that secure the display assembly to the base enclosure through the bottom of the top cover
 - ❑ Three PM2.5×7.0 screws **2** that secure the display assembly to the base enclosure through the rear panel
 - ❑ One PM2.5×5.0 screw **3** that secures the display assembly to the base enclosure through the rear panel

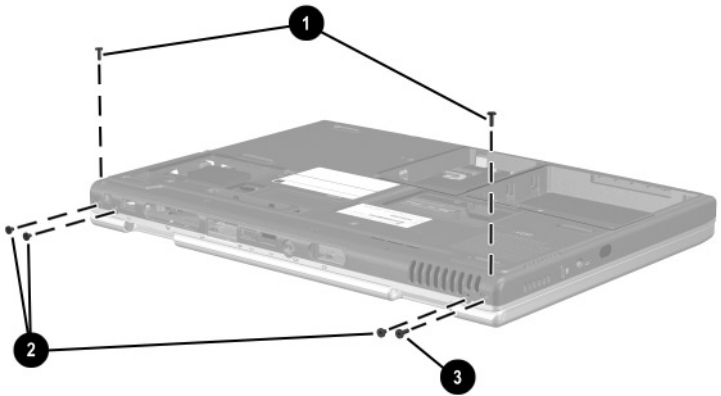

Removing the Display Screws

8. Turn the notebook right-side up with the front facing you.
9. Open the display to the fully upright position.
10. Lift the display assembly straight up and remove it.



Removing the Display Assembly

Reverse the above procedure to install the display assembly.

5.16 Top Cover

Spare Part Number Information

Top cover (includes TouchPad and TouchPad shield)	
For use with HP Pavilion zt3000 notebooks	350123-001
For use with HP Compaq nx7000 and Compaq Presario X1000 notebooks	336983-001



When replacing the top cover, determine if a Bluetooth board is installed in the defective top cover. If a board is installed, remove it from the defective top cover and install it in the replacement top cover. Refer to Section 5.17, “Bluetooth Board,” for instructions on removing and installing a Bluetooth board.

1. Prepare the notebook for disassembly (Section 5.3).
2. Disconnect the wireless antenna cables from the Mini PCI communications board (Section 5.6).
3. Remove the following components:
 - Optical drive (Section 5.8)
 - Keyboard (Section 5.9)
 - Switch cover (Section 5.10)
 - Speaker cover (Section 5.11)
 - Display assembly (Section 5.15)
4. Turn the notebook upside down, with the front facing you.

5. Remove the following screws:

- ❑ Three PM2.5×9.5 screws ❶ along the front edge of the notebook
- ❑ Two PM2.5×5.0 screws ❷ in the hard drive bay
- ❑ Six PM2.5×15.0 screws ❸
- ❑ One PM2.5×9.5 screw ❹ behind the hard drive bay

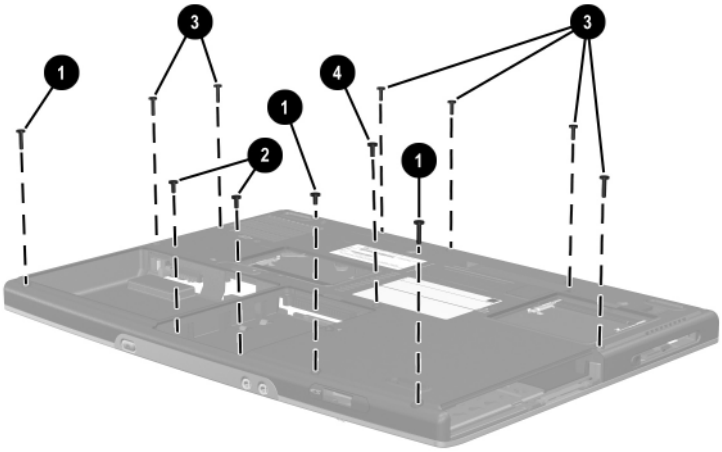

Removing the Top Cover Screws

6. Turn the notebook right-side up with the rear panel facing you.
7. Release the ZIF connector **1** to which the TouchPad cable **2** is attached and disconnect the TouchPad cable **2** from the system board.
8. Route the two antenna cables **3** out of the hole in the system board.

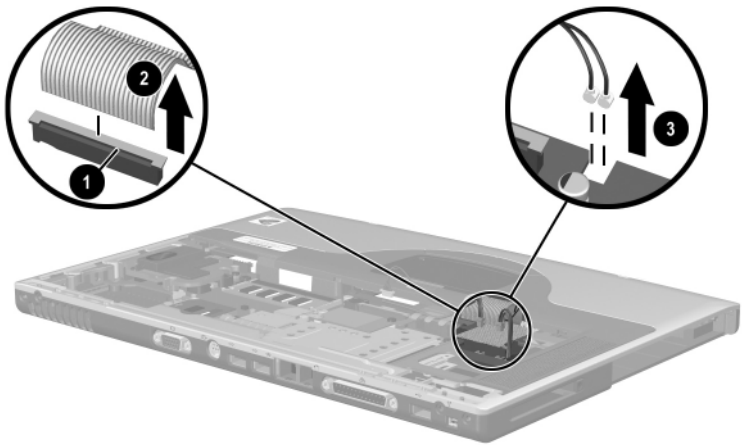

Disconnecting the TouchPad Cable and Routing the Wireless Antenna Cables

9. If connected, disconnect the Bluetooth board cable ❶ from the system board.
10. Disconnect the left ❷ and right speaker cables ❸ from the system board.

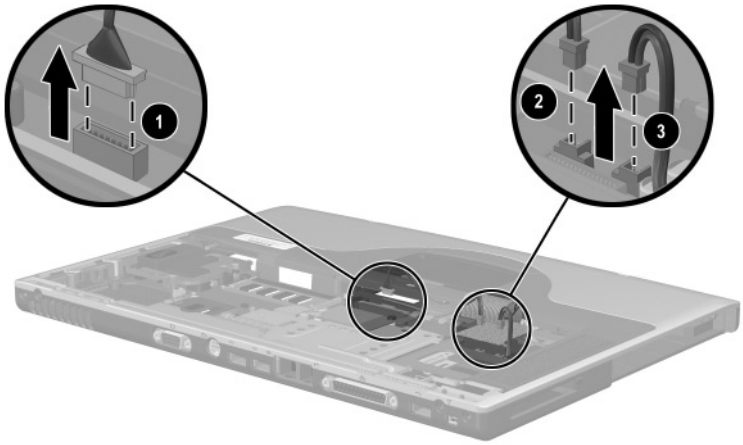

Disconnecting the Bluetooth Wireless Module and Speaker Cables

11. Position the notebook so the front faces forward.

12. Remove the following screws:

- ❑ Two PM2.5×7.0 screws ❶ that secure the top cover to the base enclosure
- ❑ One PM2.0×3.0 screw ❷ that secures the top cover and modem to the base enclosure
- ❑ One PM2.5×5.0 screw ❸ that secures the top cover to the base enclosure above the USB connector

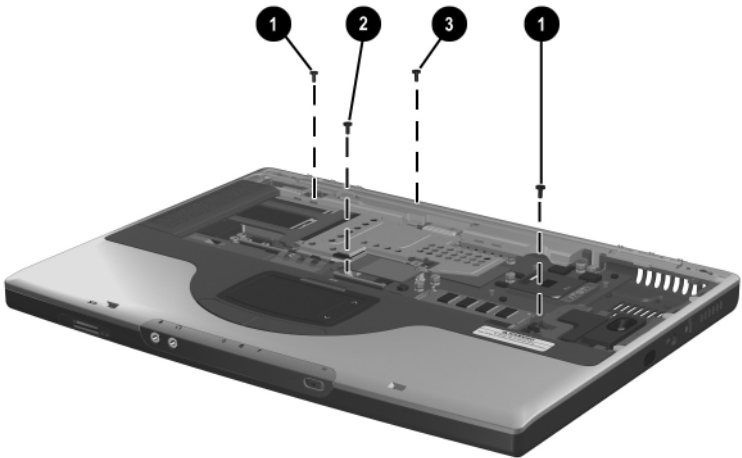

Removing the Top Cover Screws

13. Lift the back edge of the top cover ❶ and swing it forward to disengage it from the base enclosure.
14. Remove the top cover ❷.

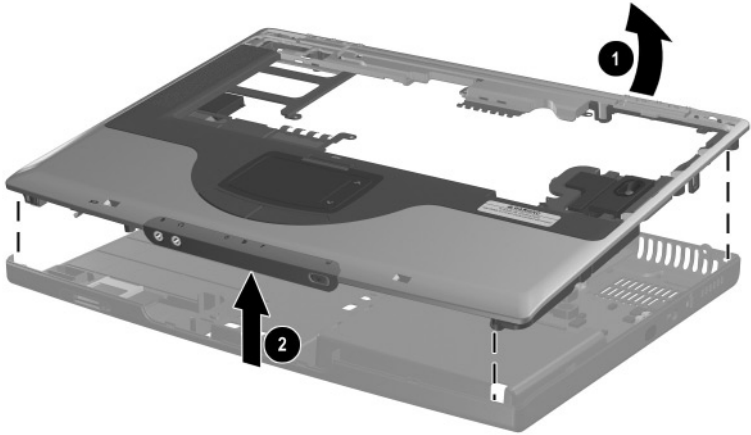

Removing the Top Cover

Reverse the above procedure to install the top cover.

5.17 Bluetooth Board

Spare Part Number Information

Bluetooth wireless communications board

338134-01

1. Prepare the notebook for disassembly (Section 5.3) and remove the following components:
 - ❑ Mini PCI communications board (Section 5.6)
 - ❑ Optical drive (Section 5.8)
 - ❑ Keyboard (Section 5.9)
 - ❑ Switch cover (Section 5.10)
 - ❑ Speaker cover (Section 5.11)
 - ❑ Display assembly (Section 5.15)
 - ❑ Top cover (Section 5.16)
2. Turn the top cover right-side up with the TouchPad facing you.

3. Disconnect the Bluetooth board cable ❶ from the Bluetooth board.



The Bluetooth board cable is included in the Miscellaneous Cable Kit, spare part number 336973-001.

4. Remove the two PM1.5×3.0 screws ❷ that secure the Bluetooth board to the top cover.
5. Slide the Bluetooth board forward ❸, then lift it up ❹ and remove it from the top cover.

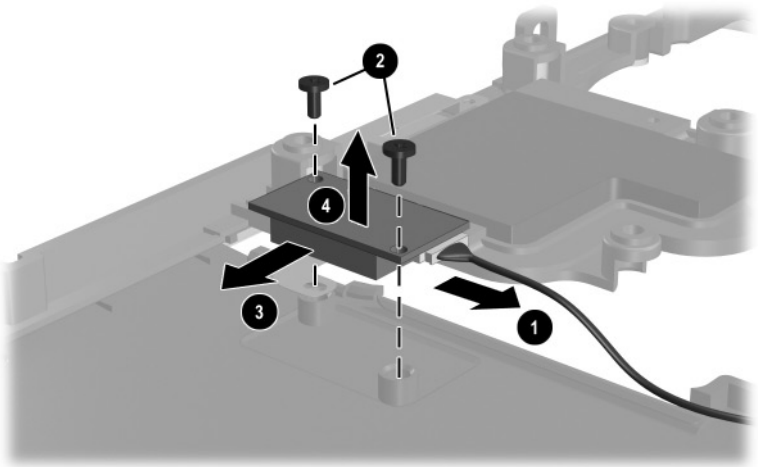

Removing the Bluetooth Board

Reverse the above procedure to install the Bluetooth board.

5.18 SD Card Slot Board and Cable

Spare Part Number Information

SD Card slot board with cable

336963-001

The SD Card slot board cable is also included in the Miscellaneous Cable Kit, spare part number 336973-001.



1. Prepare the notebook for disassembly (Section 5.3) and remove the following components:
 - ❑ Mini PCI communications board (Section 5.6)
 - ❑ Optical drive (Section 5.8)
 - ❑ Keyboard (Section 5.9)
 - ❑ Switch cover (Section 5.10)
 - ❑ Speaker cover (Section 5.11)
 - ❑ Display assembly (Section 5.15)
 - ❑ Top cover (Section 5.16)

2. Disconnect the SD Card slot board cable ❶ from the system board.
3. Remove the PM2.5×5.0 screw ❷ that secures the SD Card slot board to the notebook.
4. Remove the PM2.5×5.0 screw ❸ that secures the SD Card slot board cable ground loop to the notebook.
5. Remove the SD Card slot board and cable.

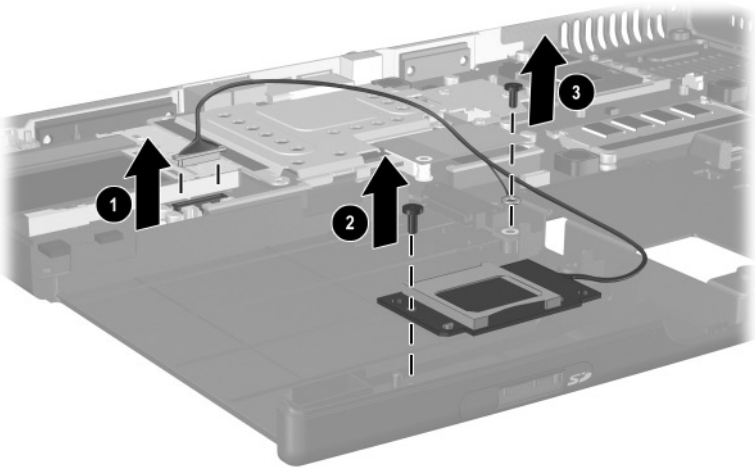

Removing the SD Card Slot Board and Cable

Reverse the above procedure to install the SD Card slot board and cable.

5.19 VGA Board and Shield

Spare Part Number Information

VGA boards (include thermal pads)

For use with HP Pavilion zt3000 notebooks

ATI MOBILITY RADEON 9200 with 64-MB video memory	350129-001
ATI MOBILITY RADEON 9200 with 32-MB video memory	350128-001

For use with HP Compaq nx7000 and
Compaq Presario X1000 notebooks

ATI MOBILITY RADEON 9200 with 64 -MB video memory	336970-001
ATI MOBILITY RADEON 9200 with 32-MB video memory	336969-001
ATI MOBILITY RADEON 7500c with 32-MB video memory	336968-001

VGA board shield (includes thermal pads) 337017-001

1. Prepare the notebook for disassembly (Section 5.3) and remove the following components:
 - ❑ Mini PCI communications board (Section 5.6)
 - ❑ Optical drive (Section 5.8)
 - ❑ Keyboard (Section 5.9)
 - ❑ Switch cover (Section 5.10)
 - ❑ Speaker cover (Section 5.11)
 - ❑ Display assembly (Section 5.12)
 - ❑ Top cover (Section 5.16)

2. Remove the PM2.5×15.0 ❶ and PM2.0×3.0 ❷ screws that secure the VGA board shield to the base enclosure.
3. Lift the upper left corner of the VGA board ❸ to disconnect it from the system board.
4. Remove the VGA board and shield ❹.
5. Disengage the shield clips ❺ to remove the VGA board from the shield.

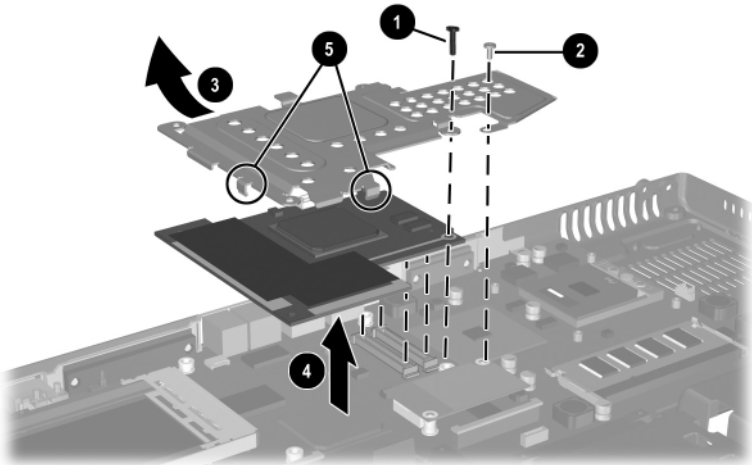

Removing the VGA Board and Shield

6. The VGA shield thermal pad ❶ and VGA board thermal pad ❷ assist in cooling the notebook. Inspect these pads and replace if necessary each time the shield is removed.

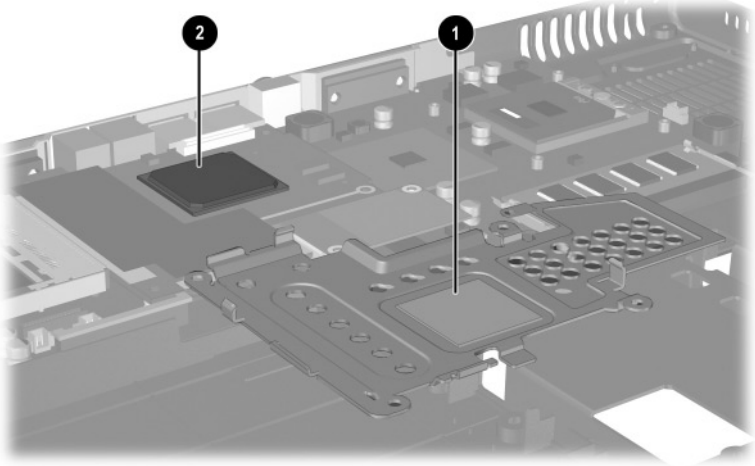

Replacing the Thermal Pads on the VGA Board and Shield

Reverse the above procedure to install the VGA board and shield.

5.20 Modem and Cable

Spare Part Number Information

Modem board with cable	336999-001
------------------------	------------

The modem board cable is also included in the Miscellaneous Cable Kit, spare part number 3361973-001.

1. Prepare the notebook for disassembly (Section 5.3) and remove the following components:
 - ❑ Mini PCI communications board (Section 5.6)
 - ❑ Optical drive (Section 5.8)
 - ❑ Keyboard (Section 5.9)
 - ❑ Switch cover (Section 5.10)

- ❑ Speaker cover (Section 5.11)
 - ❑ Display assembly (Section 5.15)
 - ❑ Top cover (Section 5.16)
 - ❑ VGA board and shield (Section 5.19)
2. Disconnect the modem cable ❶ from the system board.
 3. Lift the left side of the modem board ❷ to disconnect it from the system board.
 4. Remove the modem board.

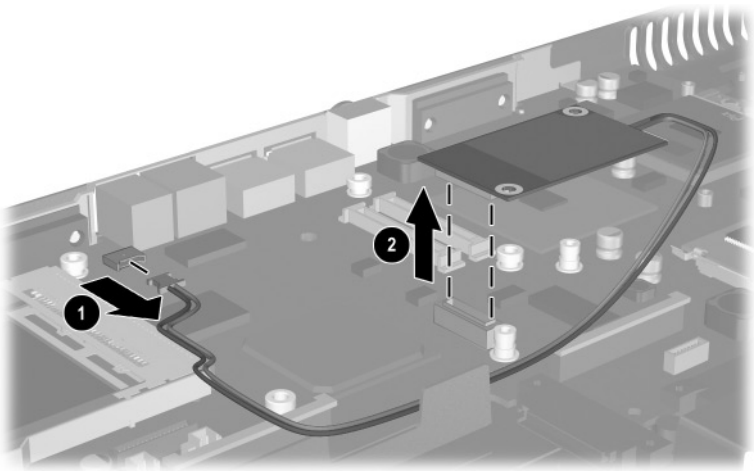

Removing the Modem Board and Cable

Reverse the above procedure to install the modem and cable.

5.21 System Board

Spare Part Number Information

System board (includes thermal pads)	336964-001
PC Card assembly (removal not documented)	337014-001



When replacing the system board, ensure that the following components are removed from the defective system board and installed on the replacement system board:

- Memory expansion boards (Section 5.5)
 - Mini PCI communications board (Section 5.6)
 - RTC battery (Section 5.7)
 - Processor (Section 5.14)
 - VGA board and shield (Section 5.19)
 - Modem and modem cable (Section 5.20)
-

1. Prepare the notebook for disassembly (Section 5.3) and remove the following components:
 - Optical drive (Section 5.8)
 - Keyboard (Section 5.9)
 - Switch cover (Section 5.10)
 - Speaker cover (Section 5.11)
 - Display assembly (Section 5.12)
 - Top cover (Section 5.16)

2. Disconnect the SD Card slot board cable ❶ from the system board.
3. Remove the PM2.5×5.0 screw ❷ that secures the SD Card slot board cable ground loop to the base enclosure and the PM2.5×5.0 screw ❸ that secures the system board to the base enclosure.

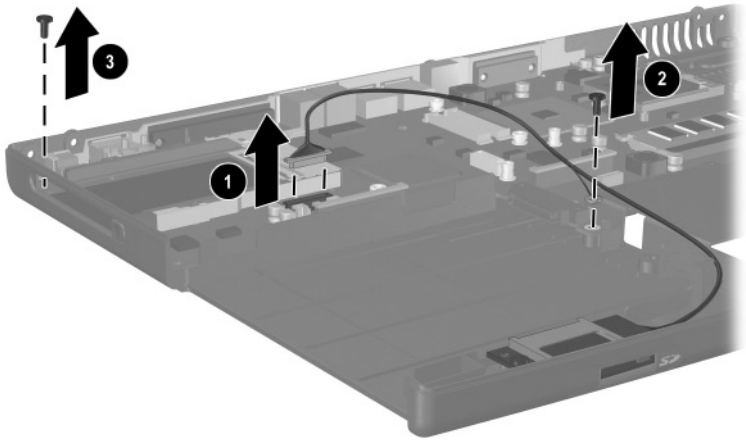

Removing the System Board Screws

4. Lift the right side of the system board approximately 1 inch ❶. If necessary, flex the back edge of the base enclosure out so that the parallel ❷ and serial connectors ❸ clear the base enclosure.
5. Slide the system board to the right at an angle ❹.
6. Remove the system board.

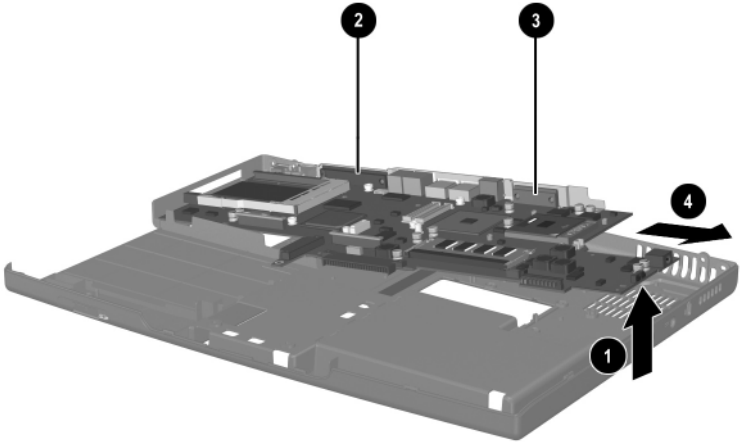

Removing the System Board

Reverse the above procedure to install the system board.

6

Specifications

This chapter provides physical and performance specifications.

Table 6-1
Notebook

Dimensions		
Height	3.45 cm	1.4 in
Width	25.40 cm	10.0 in
Depth	35.56 cm	14.0 in

Weight (varies by configuration)		
	2.95 kg	6.5 lbs

Stand-alone power requirements		
Nominal operating voltage	14.4 VDC	
Average operating power	15.8 W	
Peak operating power	38.0 W	
Power in Standby mode	< 800 mW	
Power in Hibernation mode	< 100 mW	

Temperature		
Operating (not writing optical)	0°C to 35°C	32°F to 95°F
Operating (writing optical)	5°C to 35°C	41°F to 95°F
Nonoperating	-20°C to 60°C	-4°F to 140°F

Table 6-1
Notebook (Continued)

Relative humidity (noncondensing)

Operating	10% to 90%
Nonoperating	5% to 95%, 38.7°C (101.6°F) maximum wet bulb temperature

Altitude (unpressurized)

Operating (14.7 to 10.1 psia)	-15.24 to 3,048 m	-50 to 10,000 ft
Nonoperating (14.7 to 4.4 psia)	-15.24 to 12,192 m	-50 to 40,000 ft

Shock

Operating	10 g, 11 ms, half-sine
Nonoperating	175 g, 2 ms, half-sine



Applicable product safety standards specify thermal limits for plastic surfaces. The notebook operates well within this range of temperatures.

Table 6-2
15.4-inch, Wide UXGA, TFT Display

Dimensions		
Height	20.7 cm	8.1 in
Width	33.1 cm	13.0 in
Diagonal	39.1 cm	15.4 in
Number of colors	up to 16.8 million	
Contrast ratio	300:1	
Brightness	170 nits typical	
Pixel resolution		
Pitch	0.173 × 0.173 mm	
Format	1920 × 1200	
Configuration	RGB vertical stripe	
Backlight	Edge lit	
Character display	80 × 25	
Viewing angle	+/- 55° horizontal, +/- 45° vertical typical	

Table 6-3
15.4-inch, Wide SXGA+, TFT Display

Dimensions		
Height	20.7 cm	8.1 in
Width	33.1 cm	13.0 in
Diagonal	39.1 cm	15.4 in

Number of colors	up to 16.8 million
-------------------------	--------------------

Contrast ratio	200:1
-----------------------	-------

Brightness	180 nits typical
-------------------	------------------

Pixel resolution	
Pitch	0.197 × 0.197 mm
Format	1680 × 1050
Configuration	RGB vertical stripe

Backlight	Edge lit
------------------	----------

Character display	80 × 25
--------------------------	---------

Viewing angle	+/- 65° horizontal, +/- 50° vertical typical
----------------------	--

Table 6-4
15.4-inch, Wide XGA+, TFT Display

Dimensions		
Height	20.7 cm	8.1 in
Width	33.1 cm	13.0 in
Diagonal	39.1 cm	15.4 in
Number of colors	up to 16.8 million	
Contrast ratio	200:1	
Brightness	180 nits typical	
Pixel resolution		
Pitch	0.259 × 0.259 mm	
Format	1280 × 800	
Configuration	RGB vertical stripe	
Backlight	Edge lit	
Character display	80 × 25	
Viewing angle	+/- 65° horizontal, +/- 50° vertical typical	

**Table 6-5
Hard Drives**

	80-GB	60-GB (5400- rpm)	60-GB (4200- rpm)	40-GB
User capacity per drive¹	80-GB	60-GB	40-GB	30-GB
Dimensions				
Height	9.5 mm	9.5 mm	9.5 mm	9.5 mm
Width	70 mm	70 mm	70 mm	70 mm
Weight	99 g	102 g	99 g	99 g
Interface type	ATA-5	ATA-5	ATA-5	ATA-5
Transfer rate				
Synchronous (maximum)	100 MB/ sec	100 MB/ sec	100 MB/ sec	100 MB/ sec
Security	ATA security	ATA security	ATA security	ATA security
Seek times (typical read, including setting)				
Single track	3 ms	3 ms	3 ms	3 ms
Average	13 ms	13 ms	13 ms	13 ms
Maximum	24 ms	24 ms	24 ms	24 ms
Logical blocks²	156,301,488	117,210,240	78,140,160	58,605,120
Disk rotational speed	4200 rpm	5400 rpm	4200 rpm	4200 rpm
Operating temperature	5°C to 55°C (41°F to 131°F)	5°C to 55°C (41°F to 131°F)	5°C to 55°C (41°F to 131°F)	5°C to 55°C (41°F to 131°F)

¹1 GB = 1,073,741,824 bytes.

²Actual drive specifications may differ slightly.

Certain restrictions and exclusions apply. Consult the HP Customer Support Center for details.

Table 6-6
External AC Adapter

Weight	.304 kg	0.67 lb
Power supply		
Rated input voltage	100 to 240 VAC RMS	
Rated input current	1.7 A RMS	
Rated frequency	47 to 63 Hz	

Table 6-7
8-cell, Primary Li-Ion Battery Pack

Dimensions		
Height	13.4 cm	5.25 in
Width	9.2 cm	3.63 in
Depth	1.9 cm	.75 in
Weight	.43 kg	.96 lb
Energy		
Voltage	14.8 V	
Amp-hour capacity	4.4 aH	
Watt-hour capacity	64 wH	
Temperature		
Operating	0°C to 60°C	32°F to 140°F
Nonoperating	-20°C to 60°C	-4°F to 104°F
Recharge time		
System in off mode or Standby	2 to 3 hours	
System on (depending on system power consumption)	2 to 5 hours	

Table 6-8
24X DVD/CD-RW Drive

Applicable disc	DVD-5, DVD-9, DVD-10 CD-ROM (Mode 1 and 2) CD Digital Audio CD-XA ready (Mode 2, Form 1 and 2) CD-I ready (Mode 2, Form 1 and 2) CD-R (read only) CD Plus Photo CD (single/multisession) CD-Bridge	
Center hole diameter	1.5 cm	0.59 in
Disc diameter		
Standard disc	12 cm	4.72 in
Mini disc	8 cm	3.15 in
Disc thickness	1.2 mm	0.047 in
Track pitch	0.74 μ m	
Access time		
Random	< 150 ms	
Full stroke	< 225 ms	
Audio output level	Line-out, 0.7 Vrms	
Cache buffer	128 KB/s	
Data transfer rate		
CD-R (24X)	3600 KB/s (150 KB/s at 1X CD rate)	
CD-RW (10X)	1500 KB/s (150 KB/s at 1X CD rate)	
CD-ROM (24X)	3600 KB/s (150 KB/s at 1X CD rate)	
DVD (8X)	10,800 KB/s (1352 KB/s at 1X DVD rate)	
	16.6 MB/s	
Multiword DMA mode 2		
Startup time	< 15 seconds	
Stop time	< 6 seconds	

Table 6-9
24X CD-RW Drive

Applicable disc	DVD-5, DVD-9, DVD-10 CD-ROM (Mode 1 and 2) CD Digital Audio CD-XA ready (Mode 2, Form 1 and 2) CD-I ready (Mode 2, Form 1 and 2) CD-R (read only) CD Plus Photo CD (single/multisession) CD-Bridge	
Center hole diameter	1.5 cm	0.59 in
Disc diameter		
Standard disc	12 cm	4.72 in
Mini disc	8 cm	3.15 in
Disc thickness	1.2 mm	0.047 in
Track pitch	0.74 μ m	
Access time		
Random	< 150 ms	
Full stroke	< 225 ms	
Audio output level	Line-out, 0.7 Vrms	
Cache buffer	128 KB/s	
Data transfer rate		
CD-R (24X)	3600 KB/s (150 KB/s at 1X CD rate)	
CD-RW (10X)	1500 KB/s (150 KB/s at 1X CD rate)	
CD-ROM (24X)	3600 KB/s (150 KB/s at 1X CD rate)	
DVD (8X)	10,800 KB/s (1352 KB/s at 1X DVD rate)	
	16.6 MB/s	
Multiword DMA mode 2		
Startup time	< 15 seconds	
Stop time	< 6 seconds	

Table 6-10
8X DVD-ROM Drive

Applicable disc	DVD-5, DVD-9, DVD-10 CD-ROM (Mode 1 and 2) CD Digital Audio CD-XA ready (Mode 2, Form 1 and 2) CD-I ready (Mode 2, Form 1 and 2) CD-R (read only) CD Plus Photo CD (single/multisession) CD-Bridge	
Center hole diameter	1.5 cm	0.59 in
Disc diameter		
Standard disc	12 cm	4.72 in
Mini disc	8 cm	3.15 in
Disc thickness	1.2 mm	0.047 in
Track pitch	0.74 μ m	
Access time		
Random DVD media	< 150 ms	
Full stroke DVD media	< 225 ms	
Random CD media	< 110 ms	
Full stroke CD media	< 200 ms	
Audio output level	Line-out, 0.7 Vrms	
Cache buffer	512 KB/s	
Data transfer rate		
Max 24X CD	3600 KB/s (150 KB/s at 1X CD rate)	
Max 8X DVD	10,800 KB/s (1352 KB/s at 1X DVD rate)	
	16.6 MB/s	
Multiword DMA mode 2		
Startup time	< 10 seconds	
Stop time	< 3 seconds	

Table 6-11
24X CD-ROM Drive

Applicable disc	DVD-5, DVD-9, DVD-10 CD-ROM (Mode 1 and 2) CD Digital Audio CD-XA ready (Mode 2, Form 1 and 2) CD-I ready (Mode 2, Form 1 and 2) CD-R (read only) CD Plus Photo CD (single/multisession) CD-Bridge	
Center hole diameter	1.5 cm	0.59 in
Disc diameter		
Standard disc	12 cm	4.72 in
Mini disc	8 cm	3.15 in
Disc thickness	1.2 mm	0.047 in
Track pitch	1.6 μ m	
Access time		
Random	< 150 ms	
Full stroke	< 300 ms	
Audio output level	Line-out, 0.7 Vrms	
Cache buffer	128 KB/s	
Data transfer rate		
Sustained (16X)	2400 KB/s	
Variable	1500 to 3600 KB/s (10X to 24X)	
Multiword DMA mode 2	16.6 MB/s	
Startup time	< 8 seconds	
Stop time	< 4 seconds	

**Table 6-12
System DMA**

Hardware DMA	System Function
DMA0	Available for audio
DMA1*	Entertainment audio (default; alternate = DMA0, DMA3, none)
DMA2*	Diskette drive
DMA3	ECP parallel port LPT1 (default; alternate = DMA0, none)
DMA4	DMA controller cascading (not available)
DMA5*	Available for PC Card
DMA6	Not assigned
DMA7	Not assigned

*PC Card controller can use DMA 1, 2, or 5.

**Table 6-13
System Interrupts**

Hardware IRQ	System Function
IRQ0	System timer
IRQ1	Keyboard controller
IRQ2	Cascaded
IRQ3	COM2
IRQ4	COM1
IRQ5	Audio (default)*
IRQ6	Diskette drive
IRQ7	Parallel port
IRQ8	Real time clock (RTC)
IRQ9	Infrared
IRQ10	System use
IRQ11	System use
IRQ12	Internal pointing stick or external mouse
IRQ13	Coprocessor (not available to any peripheral)
IRQ14	IDE interface (hard drive and optical drive)
IRQ15	System use
	PC Cards may assert IRQ3, IRQ4, IRQ5, IRQ7, IRQ9, IRQ10, IRQ11, or IRQ15. Either the infrared or the serial port may assert IRQ3 or IRQ4.
*Default configuration; audio possible configurations are IRQ5, IRQ7, IRQ9, IRQ10, or none.	

Table 6-14
System I/O Addresses

I/O Address (hex)	System Function (shipping configuration)
000 - 00F	DMA controller no. 1
010 - 01F	Unused
020 - 021	Interrupt controller no. 1
022 - 024	Opti chipset configuration registers
025 - 03F	Unused
02E - 02F	87334 "Super I/O" configuration for CPU
040 - 05F	Counter/timer registers
044 - 05F	Unused
060	Keyboard controller
061	Port B
062 - 063	Unused
064	Keyboard controller
065 - 06F	Unused
070 - 071	NMI enable/real time clock (RTC)
072 - 07F	Unused
080 - 08F	DMA page registers
090 - 091	Unused
092	Port A
093 - 09F	Unused
0A0 - 0A1	Interrupt controller no. 2

Table 6-14
System I/O Addresses (Continued)

I/O Address (hex)	System Function (shipping configuration)
0A2 - 0BF	Unused
0C0 - 0DF	DMA controller no. 2
0E0 - 0EF	Unused
0F0 - 0F1	Coprocessor busy clear/reset
0F2 - 0FF	Unused
100 - 16F	Unused
170 - 177	Secondary fixed disk controller
178 - 1EF	Unused
1F0 - 1F7	Primary fixed disk controller
1F8 - 200	Unused
201	Joystick (decoded in ESS1688)
202 - 21F	Unused
220 - 22F	Entertainment audio
230 - 26D	Unused
26E - 26	Unused
278 - 27F	Unused
280 - 2AB	Unused
2A0 - 2A7	Unused
2A8 - 2E7	Unused
2E8 - 2EF	Reserved serial port

Table 6-14
System I/O Addresses (Continued)

I/O Address (hex)	System Function (shipping configuration)
2F0 - 2F7	Unused
2F8 - 2FF	Infrared port
300 - 31F	Unused
320 - 36F	Unused
370 - 377	Secondary diskette drive controller
378 - 37F	Parallel port (LPT1/default)
380 - 387	Unused
388 - 38B	FM synthesizer—OPL3
38C - 3AF	Unused
3B0 - 3BB	VGA
3BC - 3BF	Reserved (parallel port/no EPP support)
3C0 - 3DF	VGA
3E0 - 3E1	PC Card controller in CPU
3E2 - 3E3	Unused
3E8 - 3EF	Internal modem
3F0 - 3F7	“A” diskette controller
3F8 - 3FF	Serial port (COM1/default)
CF8 - CFB	PCI configuration index register (PCIDIVO-1)
CFC - CFF	PCI configuration data register (PCIDIVO-1)

A

Connector Pin Assignments

Table A-1
RJ-45 Network Interface

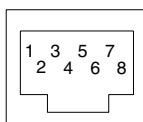

Pin	Signal	Pin	Signal
1	Transmit +	5	Unused
2	Transmit –	6	Receive –
3	Receive +	7	Unused
4	Unused	8	Unused

**Table A-2
RJ-11 Modem**



Pin	Signal	Pin	Signal
1	Unused	4	Unused
2	Tip	5	Unused
3	Ring	6	Unused

**Table A-3
Universal Serial Bus**

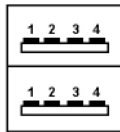

Pin	Signal	Pin	Signal
1	+5 VDC	3	Data +
2	Data -	4	Ground

**Table A-4
S-Video**

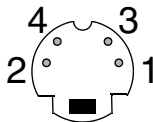

Pin	Signal	Pin	Signal
1	Ground (Y)	3	Y-Luminance (Intensity)
2	Ground (C)	4	C-Chrominance (Color)

Table A-5
External Monitor

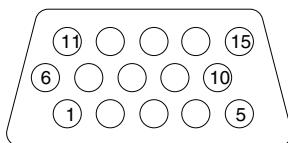

Pin	Signal	Pin	Signal
1	Red analog	9	+5 VDC
2	Green analog	10	Ground
3	Blue analog	11	Monitor detect
4	Not connected	12	DDC 2B data
5	Ground	13	Horizontal sync
6	Ground analog	14	Vertical sync
7	Ground analog	15	DDC 2B clock
8	Ground analog		

**Table A-6
Audio Line-Out**



Pin	Signal	Pin	Signal
1	Audio out	2	Ground

**Table A-7
Microphone**



Pin	Signal	Pin	Signal
1	Audio in	2	Ground

Table A-8
Parallel

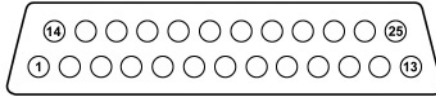

Pin	Signal	Pin	Signal
1	Strobe	14	Auto Linefeed
2	Data Bit 0	15	Error
3	Data Bit 1	16	Initialize Printer
4	Data Bit 2	17	Select In
5	Data Bit 3	18	Ground
6	Data Bit 4	19	Ground
7	Data Bit 5	20	Ground
8	Data Bit 6	21	Ground
9	Data Bit 7	22	Ground
10	Acknowledge	23	Ground
11	Busy	24	Ground
12	Paper End	25	Ground
13	Select		

Power Cord Set Requirements

3-Conductor Power Cord Set

The wide range input feature of the notebook permits it to operate from any line voltage from 100 to 120 or 220 to 240 volts AC.

The power cord set included with the notebook meets the requirements for use in the country where the equipment is purchased.

Power cord sets for use in other countries must meet the requirements of the country where the notebook is used. For more information on power cord set requirements, contact an HP authorized reseller or service provider.

General Requirements

The following requirements are applicable to all countries:

- The length of the power cord set must be at least 1.5 meters (5 feet) and a maximum of 2 meters (6.50 feet).
- All power cord sets must be approved by an acceptable accredited agency responsible for evaluation in the country where the power cord set will be used.
- The power cord set must have a minimum current capacity of 10 amps and a nominal voltage rating of 125 or 250 volts AC, as required by each country's power system.
- The appliance coupler must meet the mechanical configuration of an EN 60 320/IEC 320 Standard Sheet C13 connector for mating with the appliance inlet on the back of the notebook.

Country-Specific Requirements

3-Conductor Power Cord Set Requirements

Country	Accredited Agency	Applicable Note Number
Australia	EANSW	1
Austria	OVE	1
Belgium	CEBC	1
Canada	CSA	2
Denmark	DEMKO	1
Finland	FIMKO	1
France	UTE	1
Germany	VDE	1
Italy	IMQ	1
Japan	METI	3
The Netherlands	KEMA	1
Norway	NEMKO	1
Sweden	SEMKO	1
Switzerland	SEV	1

3-Conductor Power Cord Set Requirements (Continued)

Country	Accredited Agency	Applicable Note Number
United Kingdom	BSI	1
United States	UL	2

Notes

1. The flexible cord must be <HAR> Type HO5VV-F, 3-conductor, 1.0 mm² conductor size. Power cord set fittings (appliance coupler and wall plug) must bear the certification mark of the agency responsible for evaluation in the country where it will be used.
 2. The flexible cord must be Type SPT-3 or equivalent, No. 18 AWG, 3-conductor. The wall plug must be a two-pole grounding type with a NEMA 5-15P (15 A, 125 V) or NEMA 6-15P (15 A, 250 V) configuration.
 3. The appliance coupler, flexible cord, and wall plug must bear a "T" mark and registration number in accordance with the Japanese Dentori Law. The flexible cord must be Type VCT or VCTF, 3-conductor, 1.00 mm² conductor size. The wall plug must be a two-pole grounding type with a Japanese Industrial Standard C8303 (7 A, 125 V) configuration.
-

Screw Listing

This appendix provides specification and reference information for the screws used in the notebook. All screws listed in this appendix are available in the Miscellaneous Screw Kit, spare part number 337012-001.

Table C-1
Phillips PM2.5×9.5 Screw

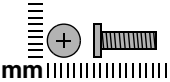
 mm	Color	Qty.	Length	Thread	Head Width
	Black	9	9.5 mm	2.5 mm	5.0 mm

Where used:

- ❶ Two screws that secure the hard drive to the notebook (documented in Section 5.3)
- ❷ One screw that secures the optical drive to the notebook (documented in Section 5.8)
- ❸ Two screws that secure the display assembly to the notebook (documented in Section 5.15)

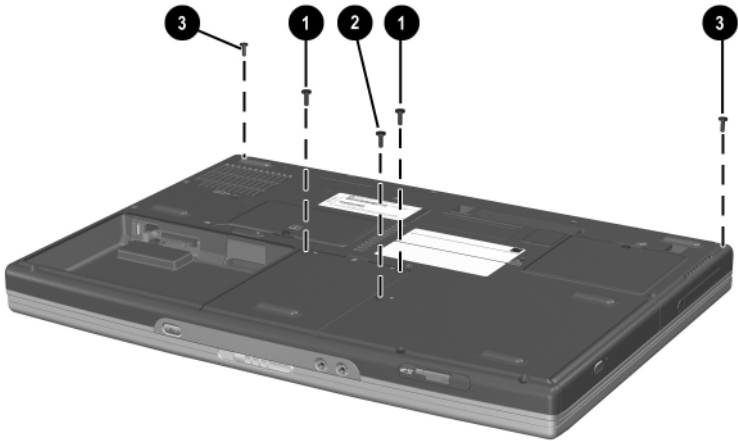

Phillips PM2.5×9.5 Screw Locations

Table C-1
Phillips PM2.5×9.5 Screw (Continued)

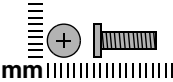
	Color	Qty.	Length	Thread	Head Width
	Black	9	9.5 mm	2.5 mm	5.0 mm

Where used:

Four screws that secure the top cover to the notebook
 (documented in Section 5.16)

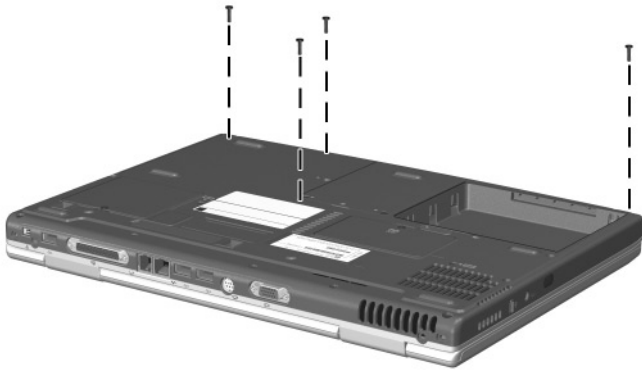

Phillips PM2.5×7.0 Screw Locations

Table C-2
Phillips PM2.5×7.0 Screw

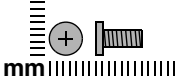
	Color	Qty.	Length	Thread	Head Width
	Black	5	7.0 mm	2.5 mm	5.0 mm

Where used:

Three screws that secure the display assembly to the notebook through the rear panel (documented in Section 5.15)



Phillips PM2.5×7.0 Screw Locations

Table C-2
Phillips PM2.5×7.0 Screw (Continued)

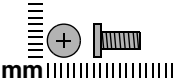
	Color	Qty.	Length	Thread	Head Width
	Black	5	7.0 mm	2.5 mm	5.0 mm

Where used:

Two screws that secure the top cover to the notebook
 (documented in Section 5.16)

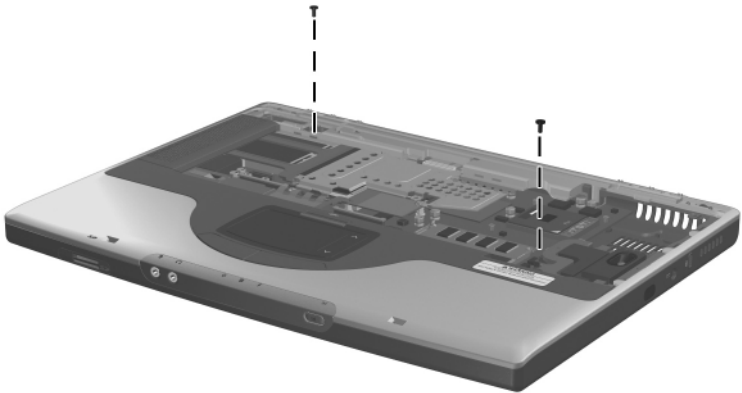

Phillips PM2.5×7.0 Screw Locations

Table C-3
Phillips PM2.5×3.5 Screw

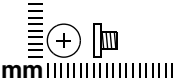
	Color	Qty.	Length	Thread	Head Width
	Silver	4	3.5 mm	2.5 mm	5.0 mm

Where used:

Four screws that secure the hard drive to the hard drive cover and shield (documented in Section 5.3)

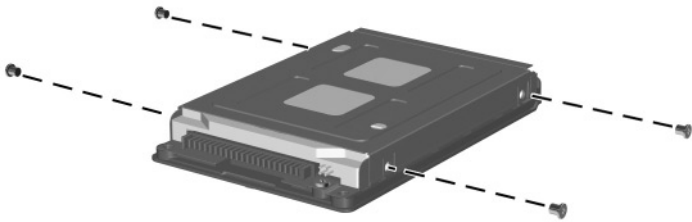

Phillips PM2.5×3.5 Screw Locations

Table C-4
Phillips PM2.5×5.0 Screw

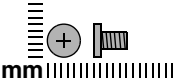
	Color	Qty.	Length	Thread	Head Width
	Black	13	5.0 mm	2.5 mm	5.0 mm

Where used:

- ❶ One screw that secures the memory expansion compartment cover to the notebook (documented in Section 5.5)
- ❷ One screw that secures the Mini PCI compartment cover to the notebook (documented in Section 5.6)

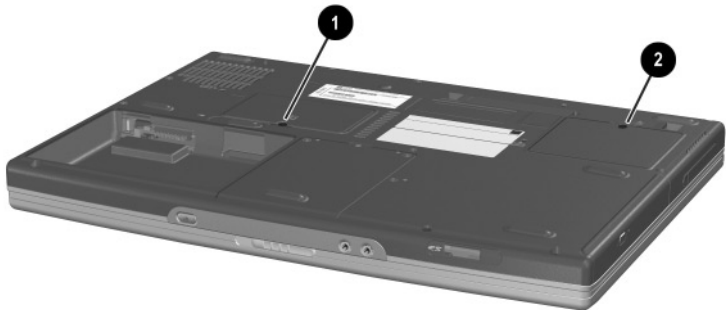

Phillips PM2.5×5.0 Screw Locations

Table C-4
Phillips PM2.5×5.0 Screw (Continued)

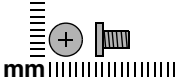
	Color	Qty.	Length	Thread	Head Width
	Black	13	5.0 mm	2.5 mm	5.0 mm

Where used:

- ❶ Three screws that secure the speaker cover to the notebook (documented in Section 5.11)
- ❷ One screw that secures the fan to the notebook (documented in Section 5.12)

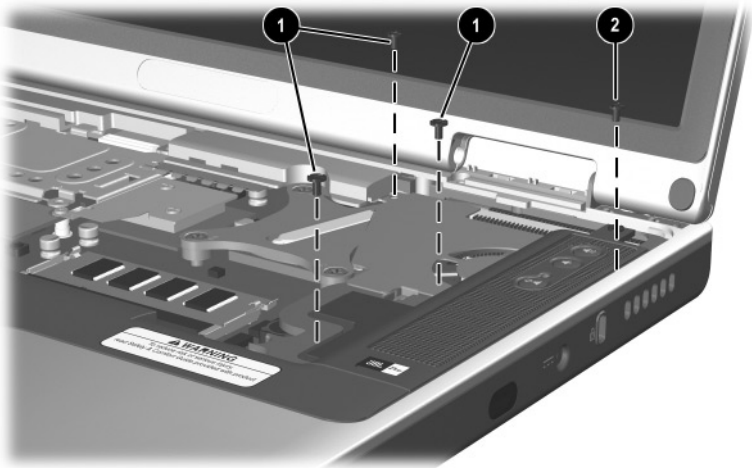

Phillips PM2.5×5.0 Screw Locations

Table C-4
Phillips PM2.5×5.0 Screw (Continued)

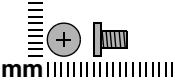
	Color	Qty.	Length	Thread	Head Width
	Black	13	5.0 mm	2.5 mm	5.0 mm

Where used:

One screw that secures the display assembly to the notebook through the rear panel (documented in Section 5.15)



Phillips PM2.5×5.0 Screw Locations

Table C-4
Phillips PM2.5×5.0 Screw (Continued)

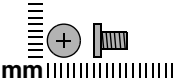
	Color	Qty.	Length	Thread	Head Width
	Black	13	5.0 mm	2.5 mm	5.0 mm

Where used:

Two screws that secure the top cover to the notebook in the hard drive bay (documented in Section 5.16)

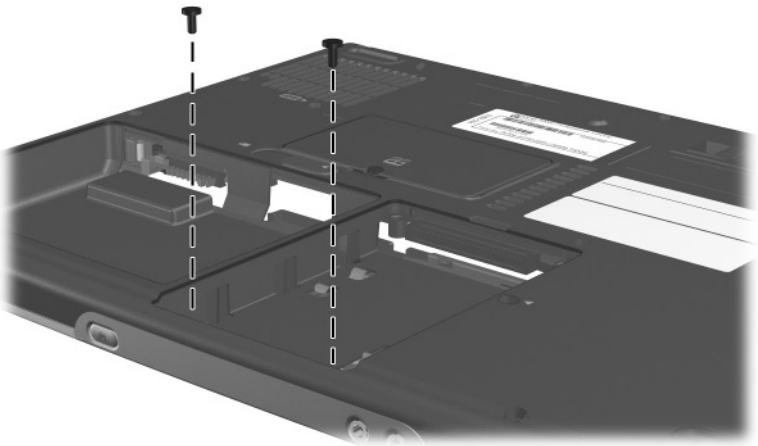

Phillips PM2.5×5.0 Screw Locations

Table C-4
Phillips PM2.5×5.0 Screw (Continued)

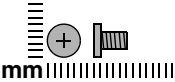
	Color	Qty.	Length	Thread	Head Width
	Black	13	5.0 mm	2.5 mm	5.0 mm

Where used:

One screw that secures the top cover to the notebook
 (documented in Section 5.16)

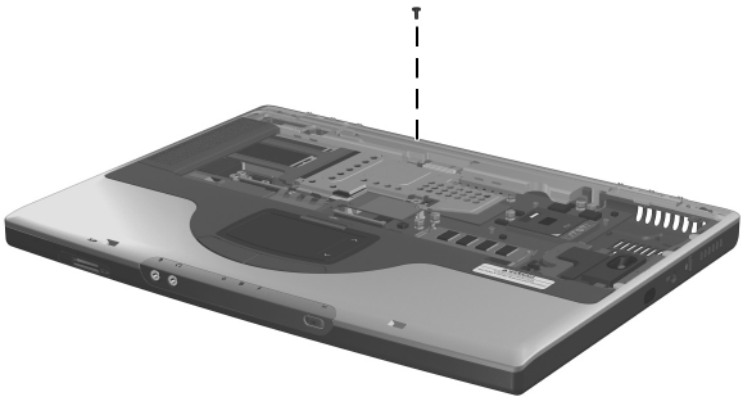

Phillips PM2.5×5.0 Screw Location

Table C-4
Phillips PM2.5×5.0 Screw (Continued)

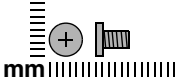
	Color	Qty.	Length	Thread	Head Width
	Black	13	5.0 mm	2.5 mm	5.0 mm

Where used:

Two screws that secure the SD Card slot board and cable to the notebook (documented in Section 5.18)

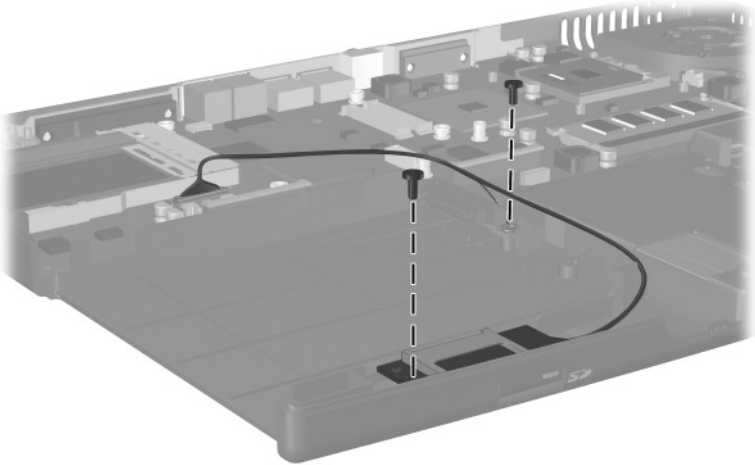

Phillips PM2.5×5.0 Screw Locations

Table C-4
Phillips PM2.5×5.0 Screw (Continued)

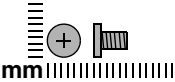
	Color	Qty.	Length	Thread	Head Width
	Black	13	5.0 mm	2.5 mm	5.0 mm

Where used:

One screw that secures the system board to the notebook (documented in Section 5.21)

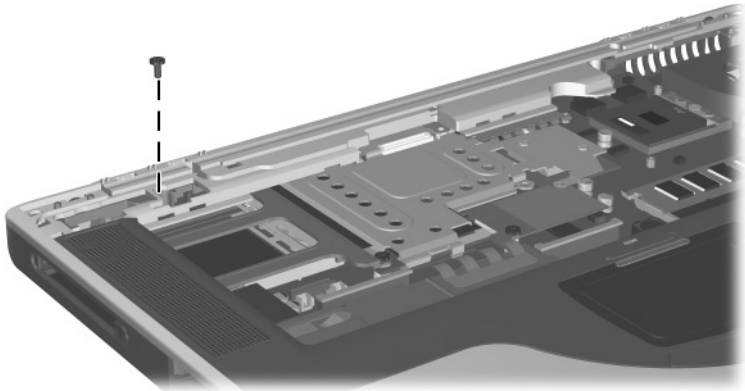

Phillips PM2.5×5.0 Screw Location

Table C-5
Phillips PM2.5×15.0 Screw

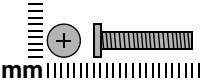
	Color	Qty.	Length	Thread	Head Width
	Black	10	15.0 mm	2.5 mm	5.0 mm

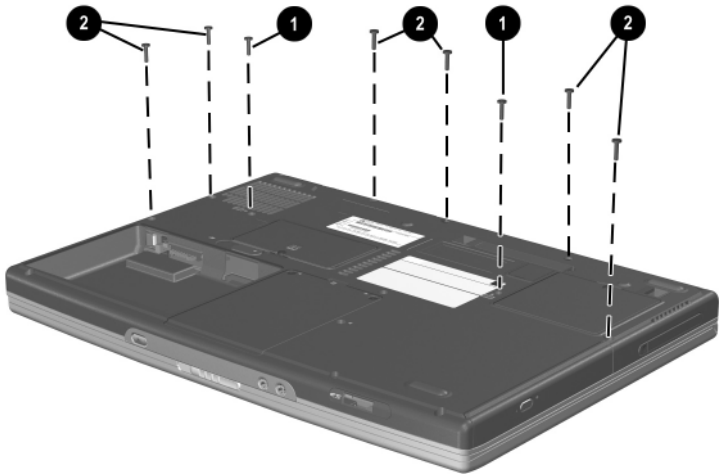

Where used:

- ❶ Two screws that secure the keyboard to the notebook (documented in Section 5.9)
- ❷ Six screws that secure the top cover to the notebook (documented in Section 5.16)

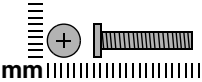

Phillips PM2.5×15.0 Screw Locations

Table C-5
Phillips PM2.5×15.0 Screw (Continued)

	Color	Qty.	Length	Thread	Head Width
mm 	Black	10	15.0 mm	2.5 mm	5.0 mm

Where used:

One screw that secures the display assembly cable to the notebook (documented in Section 5.15)

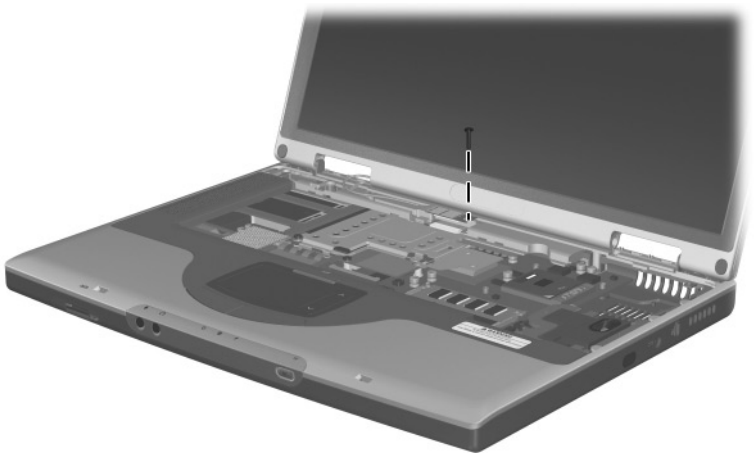

Phillips PM2.5×15.0 Screw Location

Table C-5
Phillips PM2.5×15.0 Screw (Continued)

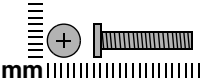
 mm	Color	Qty.	Length	Thread	Head Width
	Black	10	15.0 mm	2.5 mm	5.0 mm

Where used:

One screw that secures the VGA shield to the notebook (documented in Section 5.19)

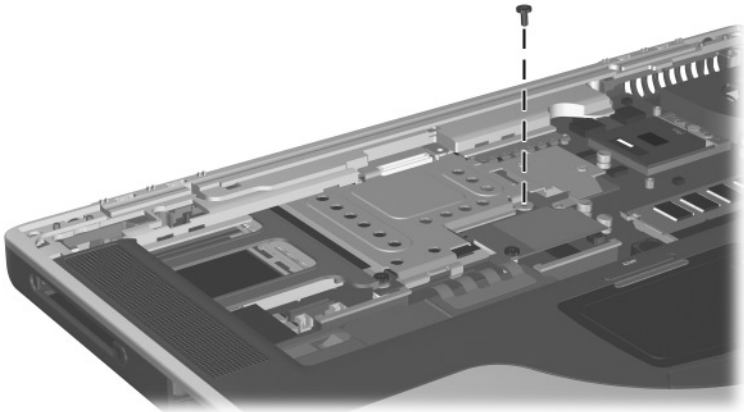

Phillips PM2.5×15.0 Screw Location

Table C-6
Phillips PM2.5×3.0 Screw

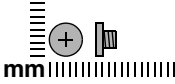
	Color	Qty.	Length	Thread	Head Width
	Black	1	3.0 mm	2.5 mm	5.0 mm

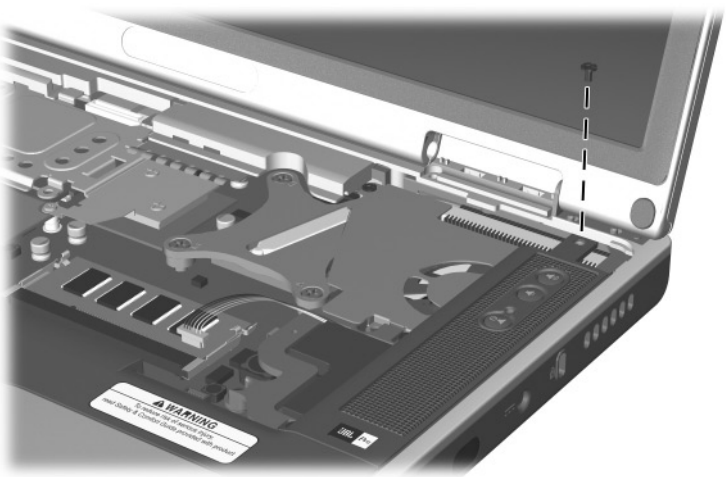

Where used:

One screw that secures the speaker cover to the notebook
 (documented in Section 5.11)

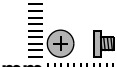

Phillips PM2.5×3.0 Screw Location

Table C-7
Phillips PM2.0×3.0 Screw

 mm 	Color	Qty.	Length	Thread	Head Width
	Black	2	3.0 mm	2.0 mm	4.0 mm

Where used:

- ❶ One screw that secures the top cover to the notebook (documented in Section 5.16)
- ❷ One screw that secures the VGA shield to the notebook (documented in Section 5.19)

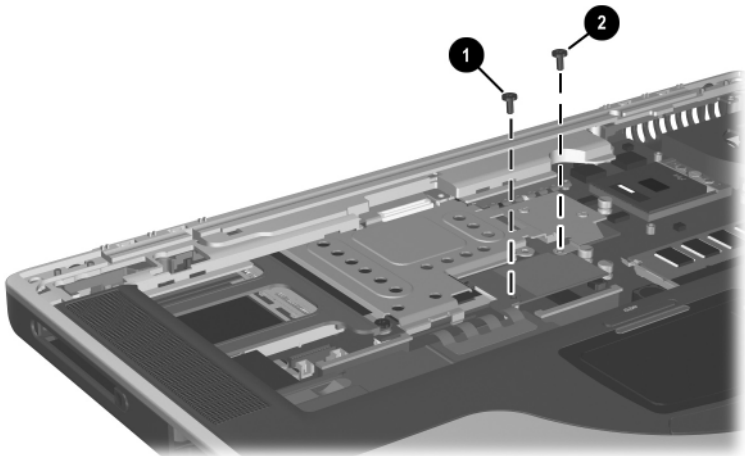

Phillips PM2.0×3.0 Screw Locations

Table C-8
Phillips PM2.0×9.0 Spring-Loaded Screw

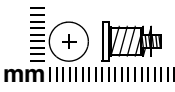
	Color	Qty.	Length	Thread	Head Width
	Silver	4	9.0 mm	2.0 mm	6.0 mm

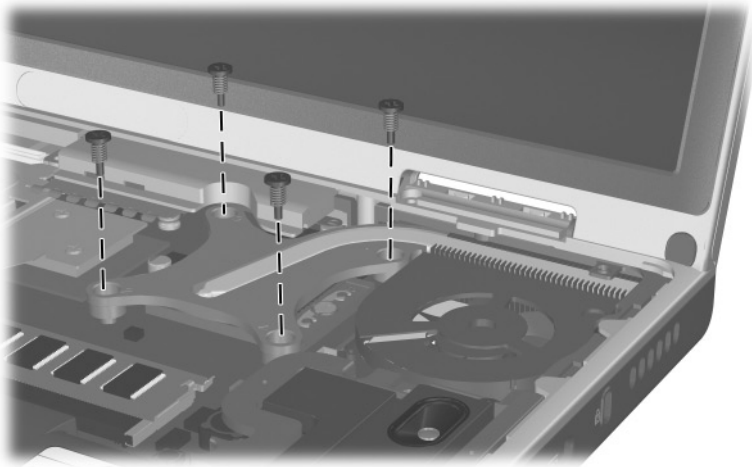

Where used:

Four screws that secure the heat sink to the notebook
 (documented in Section 5.13)



Phillips PM2.0×9.0 Spring-Loaded Screw Locations

Table C-9
Phillips PM1.5x3.0 Screw

 mm 	Color	Qty.	Length	Thread	Head Width
	Silver	2	3.0 mm	1.5 mm	2.0 mm

Where used:

Two screws that secure the Bluetooth board to the top cover
(documented in Section 5.17)

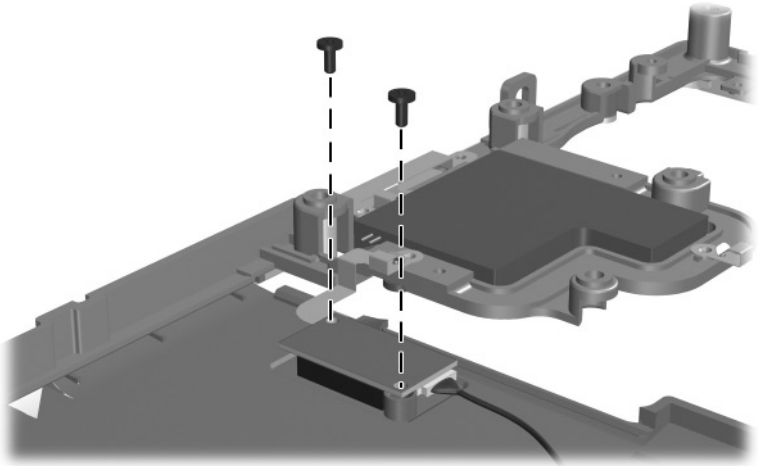

Phillips PM1.5x3.0 Screw Locations

Index

1394 connector, location 1–29
802.11b wireless LAN, spare
part numbers 3–9, 5–11

A

AC adapter
 spare part number 3–15
 specifications 6–7
applications key, location
 1–31
audio line-out jack
 location 1–27
 pin assignments A–4
audio troubleshooting 2–21

B

base enclosure, spare part
 number 3–7
battery bay, location 1–35
battery pack
 removal 5–4
 spare part number 3–9
 specifications 6–7
battery pack release latch,
 location 1–35

Bluetooth wireless
 communications board
 removal 5–36
 spare part number 3–5,
 3–9, 5–11, 5–36
bottom components 1–34

C

cables, service considerations
 4–2
caps lock light, location 1–33
CD-ROM drive
 removal 5–14
 spare part number 5–14
 specifications 6–11
CD-RW drive, specifications
 6–9
components
 bottom 1–34
 front 1–26
 keyboard 1–30
 left-side 1–26
 rear panel 1–28
 right-side 1–28
 top 1–32

- Computer Setup
 - Advanced Menu 2–5
 - File Menu 2–3
 - overview 2–1
 - Security Menu 2–4
- connector pin assignments
 - audio line-out jack A–4
 - external monitor connector A–3
 - microphone jack A–4
 - modem jack A–2
 - monitor connector A–3
 - network jack A–1
 - RJ-11 telephone jack A–2
 - RJ-45 network jack A–1
 - S-Video connector A–2
 - Universal Serial Bus (USB) connector A–2
- connectors, service considerations 4–2
- cursor control keys, location 1–31
- D**
- design overview 1–36
- Diagnostics for Windows 2–1
- disassembly sequence chart 5–3
- display assembly
 - removal 5–26
 - spare part numbers 3–3, 5–26
 - specifications 6–3, 6–4, 6–5
- display inverter, spare part number 3–3, 5–26
- display lid switch, location 1–33
- display release latch, location 1–27
- DMA specifications 6–12
- docking connector cover 3–10
- docking connector, location 1–35
- drives, preventing damage 4–3
- DVD-ROM drive
 - removal 5–14
 - spare part number 5–14
 - specifications 6–10
- E**
- electrostatic discharge 4–4, 4–7
- external monitor connector
 - location 1–29
 - pin assignments A–3
- F**
- F1 through F12 function keys, location 1–31
- fan
 - removal 5–21
 - spare part number 3–7, 5–21
- features 1–22
- feet
 - illustrated 3–10
 - locations 5–8
- Fn key, location 1–31
- front components 1–26

G

grounding equipment and methods 4–6

H

hard drive
OS loading problems 2–17
removal 5–6
spare part numbers 3–9, 3–14, 5–6
specifications 6–6

hard drive bay, location 1–35

hard drive connector, illustrated 3–10

hard drive cover
illustrated 3–10
removal 5–7

hard drive shield
illustrated 3–10
removal 5–7

heat sink
removal 5–22
spare part number 3–7, 5–22

I

I/O address specifications 6–14

infrared port 1–28

internal keypad, location 1–31

interrupt specifications 6–13

K

keyboard
components 1–30
removal 5–15
spare part numbers 3–5, 5–15
troubleshooting 2–24

L

left-side components 1–26

Logo Kit, spare part numbers 3–15

M

mass storage devices, spare part numbers 3–14

memory expansion board
removal 5–9
spare part numbers 3–9

memory expansion compartment cover
illustrated 3–13
location 1–35
removal 5–9

microphone jack
location 1–27
pin assignments A–4

Mini PCI communications board
removal 5–11
spare part numbers 3–9, 5–11

- Mini PCI compartment cover
 - illustrated 3-13
 - location 1-35
 - removal 5-11
- Miscellaneous Cable Kit
 - components 3-5, 3-12
 - spare part number 3-5, 3-12, 3-13
- Miscellaneous Doors/Covers Kit
 - components 3-9
 - spare part number 3-9
- Miscellaneous Plastics Kit
 - components 3-3, 3-10
 - spare part numbers 3-3, 3-11
- models 1-2
- modem
 - cable 3-12, 3-13
 - jack, pin assignments A-2
 - removal 5-42
 - spare part number 3-9, 5-42
 - troubleshooting 2-26
- monitor connector
 - location 1-29
 - pin assignments A-3
- mute button, location 1-33
- N**
 - network jack, pin assignments A-1
 - network, troubleshooting 2-26
 - nonfunctioning device, troubleshooting 2-15, 2-23

- notebook specifications 6-1
- num lk key, location 1-31
- num lock light, location 1-33

- O**
 - operating system loading, troubleshooting 2-16
 - optical drive
 - location 1-27
 - removal 5-14
 - spare part numbers 3-5, 3-14, 5-14

- P**
 - packing precautions 4-4
 - parallel connector
 - location 1-29
 - pin assignments A-5
 - password, clearing 1-24
 - PC Card assembly, spare part number 3-7
 - PC Card eject button, location 1-27
 - PC Card slot, location 1-27
 - PC Card space saver 3-10
 - plastic parts 4-2
 - pointing device, troubleshooting 2-25
 - port replicator, troubleshooting 2-15
 - power button 1-32
 - power connector 1-28
 - power cord, spare part numbers 3-15, 3-16
 - power management features 1-25

- power, troubleshooting 2–9
- processor
 - removal 5–24
 - spare part numbers 3–7, 5–24
- R**
- rear panel components 1–28
- removal
 - preliminaries 4–1
 - procedures 5–1
- replacement
 - preliminaries 4–1
 - procedures 5–1
- right-side components 1–28
- RJ-11 telephone jack
 - location 1–29
 - pin assignments A–2
- RJ-45 network jack
 - location 1–29
 - pin assignments A–1
- RTC (real time clock) battery
 - illustrated 3–13
 - removal 5–13
- RTC (real time clock) battery cover
 - illustrated 3–13
 - location 1–34
- S**
- Screw Kit, spare part number 3–16
- SD Card slot board
 - removal 5–38
 - spare part number 3–7, 5–38
- SD Card slot board cable 3–12, 3–13
- SD Card slot, location 1–27
- security cable slot, location 1–29
- serial number 3–1, 5–2
- service considerations 4–2
- speaker cover
 - removal 5–19
 - spare part numbers 3–5, 5–19
- speaker cover cable 3–12, 3–13
- speakers, location 1–32
- specifications
 - AC adapter 6–7
 - battery pack 6–7
 - CD-ROM drive 6–11
 - CD-RW drive 6–9
 - display 6–3, 6–4, 6–5
 - DMA 6–12
 - DVD-ROM drive 6–10
 - hard drive 6–6
 - I/O addresses 6–14
 - interrupts 6–13
 - notebook 6–1
- static shielding materials 4–7
- S-Video connector
 - location 1–29
 - pin assignments A–2
- switch cover
 - illustrated 3–10
 - removal 5–18

- system board
 - removal 5-44
 - spare part number 3-7, 5-44

T

- thermal pad
 - replacement 5-22
 - spare part number 3-7, 5-22
- tools required 4-1
- top components 1-32
- top cover
 - removal 5-30
 - spare part numbers 3-5, 5-30
- TouchPad buttons, location 1-33
- TouchPad light, location 1-33
- TouchPad on/off button, location 1-33
- TouchPad scroll zones, location 1-33
- TouchPad, location 1-33
- transporting precautions 4-4
- troubleshooting
 - audio 2-21
 - Computer Setup 2-2
 - flowcharts 2-7
 - keyboard 2-24
 - modem 2-26
 - network 2-26
 - nonfunctioning device 2-15, 2-23
 - operating system loading 2-16

- overview 2-1
- pointing device 2-25
- port replicator 2-15
- power 2-9
- video 2-13

U

- Universal Serial Bus (USB)
 - connector
 - location 1-29
 - pin assignments A-2

V

- vent, location 1-29, 1-34
- VGA board
 - removal 5-40
 - spare part numbers 3-7, 5-40
- VGA board shield
 - removal 5-40
 - spare part number 3-7, 5-40
- video troubleshooting 2-13
- volume buttons, location 1-33

W

- Windows logo key, location 1-31
- wireless antenna
 - disconnection 5-12
 - spare part number 3-7
- wireless device button, location 1-27
- workstation precautions 4-5